

NPN Silicon Epitaxial Planar Transistor
for general purpose and switching applications

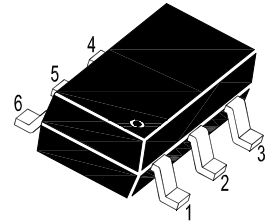
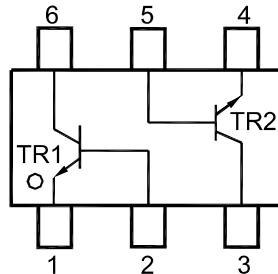

1. Emitter 2. Base 3. Collector
4. Emitter 5. Base 6. Collector
SOT-363 Plastic Package

Absolute Maximum Ratings (T_a = 25°C)

Parameter	Symbol	Value	Unit
Collector Base Voltage	V _{CB0}	80	V
BC846DW		50	
BC847DW BC848DW		30	
Collector Emitter Voltage	V _{CEO}	65	V
BC846DW		45	
BC847DW BC848DW		30	
Emitter Base Voltage	V _{EBO}	6	V
BC846DW		6	
BC847DW BC848DW		5	
Collector Current	I _C	100	mA
Peak Collector Current	I _{CM}	200	mA
Total Power Dissipation	P _{tot}	250	mW
Junction Temperature	T _j	150	°C
Storage Temperature Range	T _{stg}	- 55 to + 150	°C

Characteristics at $T_a = 25^\circ\text{C}$

Parameter	Symbol	Min.	Max.	Unit	
DC Current Gain at $V_{CE} = 5\text{ V}$, $I_C = 2\text{ mA}$	BC846ADW~BC848ADW	h_{FE}	110	220	-
	BC846BDW~BC848BDW	h_{FE}	200	450	-
	BC846CDW~BC848CDW	h_{FE}	420	800	-
Collector Base Voltage at $I_C = 10\text{ }\mu\text{A}$	BC846DW	V_{CBO}	80	-	V
	BC847DW		50	-	
	BC848DW		30	-	
Collector Emitter Voltage at $I_C = 10\text{ mA}$	BC846DW	V_{CEO}	65	-	V
	BC847DW		45	-	
	BC848DW		30	-	
Emitter Base Voltage at $I_E = 1\text{ }\mu\text{A}$	BC846DW	V_{EBO}	6	-	V
	BC847DW		6	-	
	BC848DW		5	-	
Collector Base Cutoff Current at $V_{CB} = 30\text{ V}$	I_{CBO}	-	15	nA	
Emitter Base Cutoff Current at $V_{EB} = 5\text{ V}$	I_{EBO}	-	100	nA	
Collector Emitter Saturation Voltage at $I_C = 10\text{ mA}$, $I_B = 0.5\text{ mA}$ at $I_C = 100\text{ mA}$, $I_B = 5\text{ mA}$	$V_{CE(sat)}$	-	0.25	V	
		-	0.6		
Base Emitter Voltage at $V_{CE} = 5\text{ V}$, $I_C = 2\text{ mA}$ at $V_{CE} = 5\text{ V}$, $I_C = 10\text{ mA}$	V_{BE}	0.58	0.7	V	
		-	0.77		
Transition Frequency at $V_{CE} = 5\text{ V}$, $I_C = 10\text{ mA}$, $f = 100\text{ MHz}$	f_T	100	-	MHz	
Collector Output Capacitance at $V_{CB} = 10\text{ V}$, $I_E = 0$, $f = 1\text{ MHz}$	C_{ob}	-	4.5	pF	

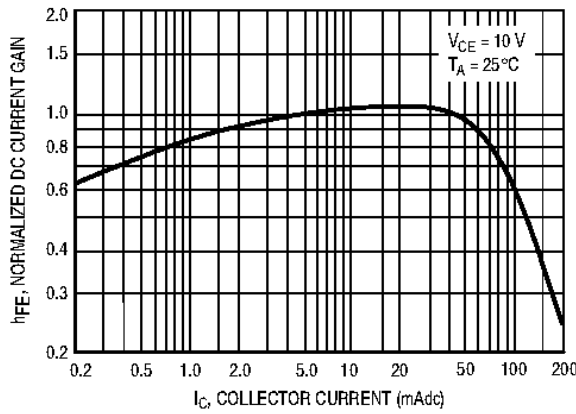

Normalized DC Current Gain

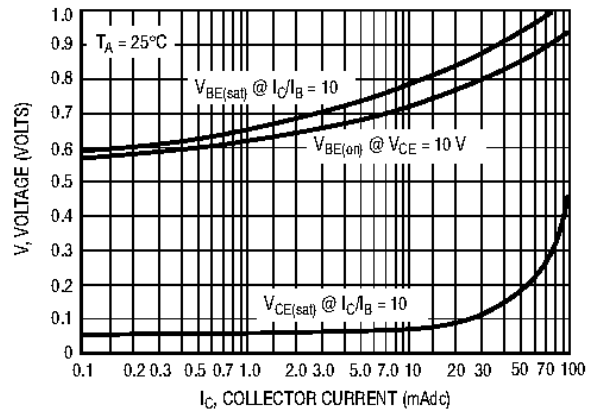

“Saturation” and “On” Voltages

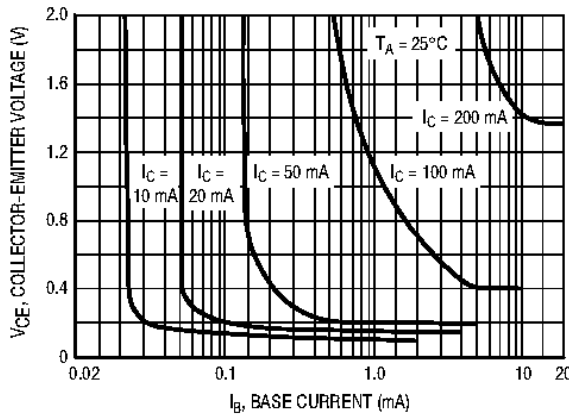

Collector Saturation Region

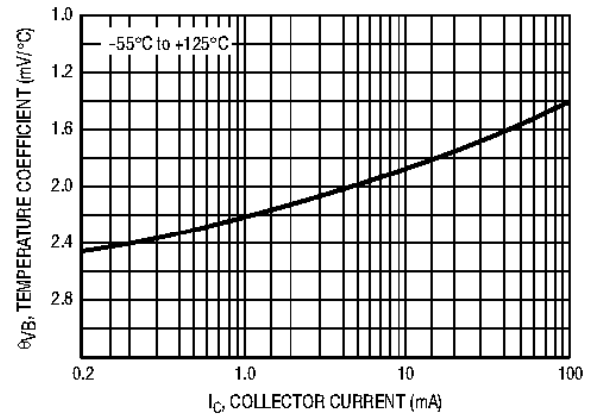

Base-Emitter Temperature Coefficient

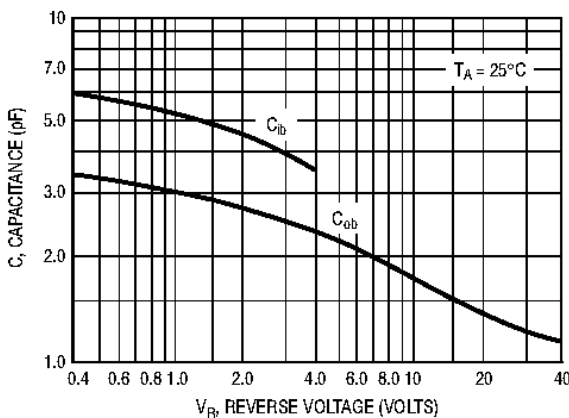

Capacitances

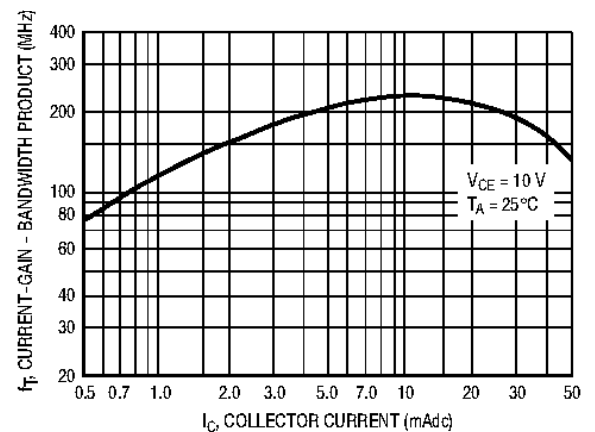

Current-Gain - Bandwidth Product

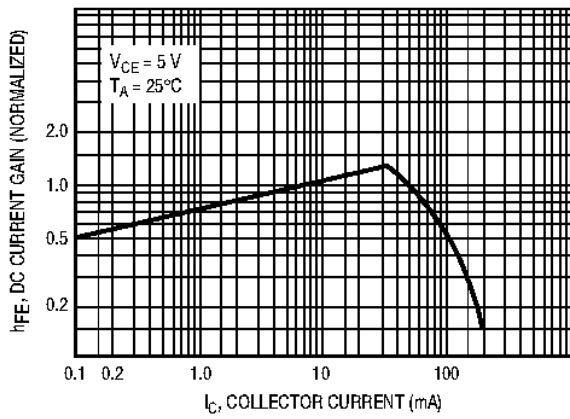

DC Current Gain

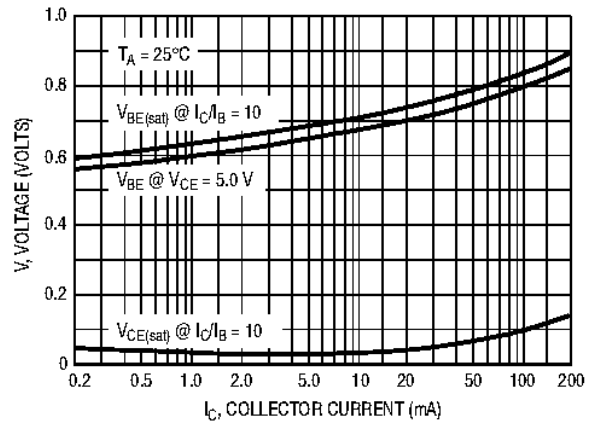

"On" Voltage

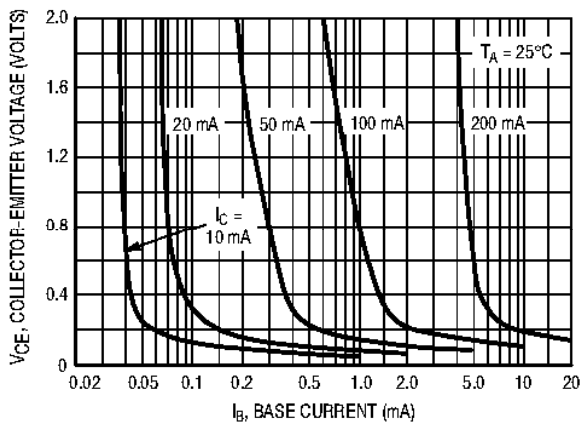

Figure 9. Collector Saturation Region

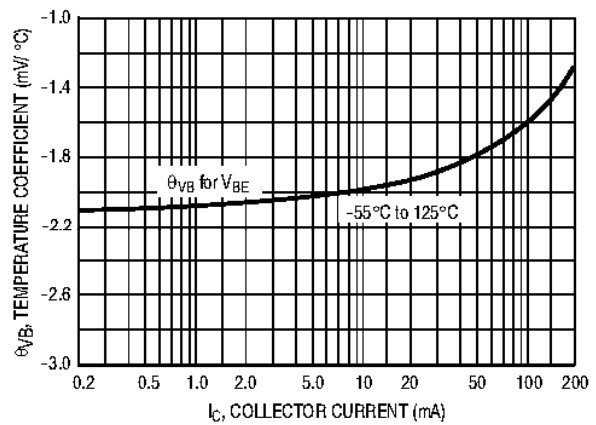

Figure 10. Base-Emitter Temperature Coefficient

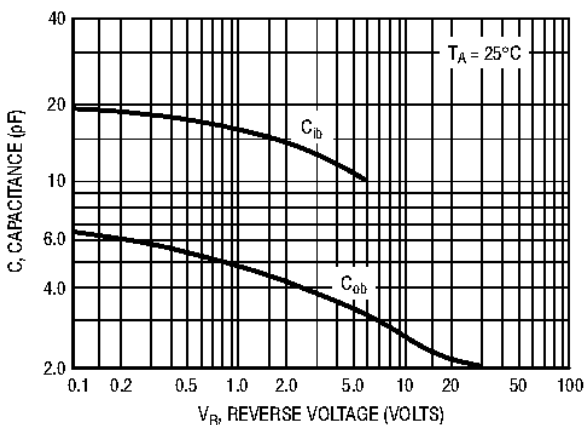

Figure 11. Capacitance

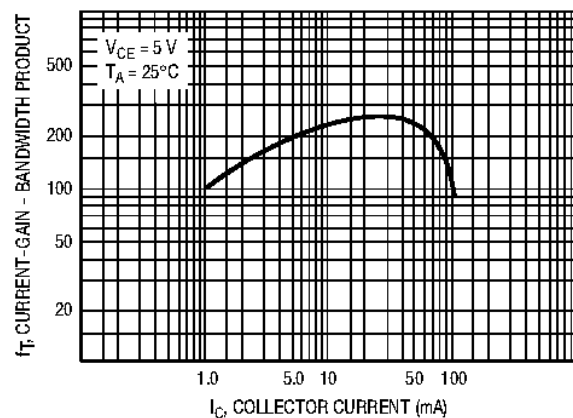
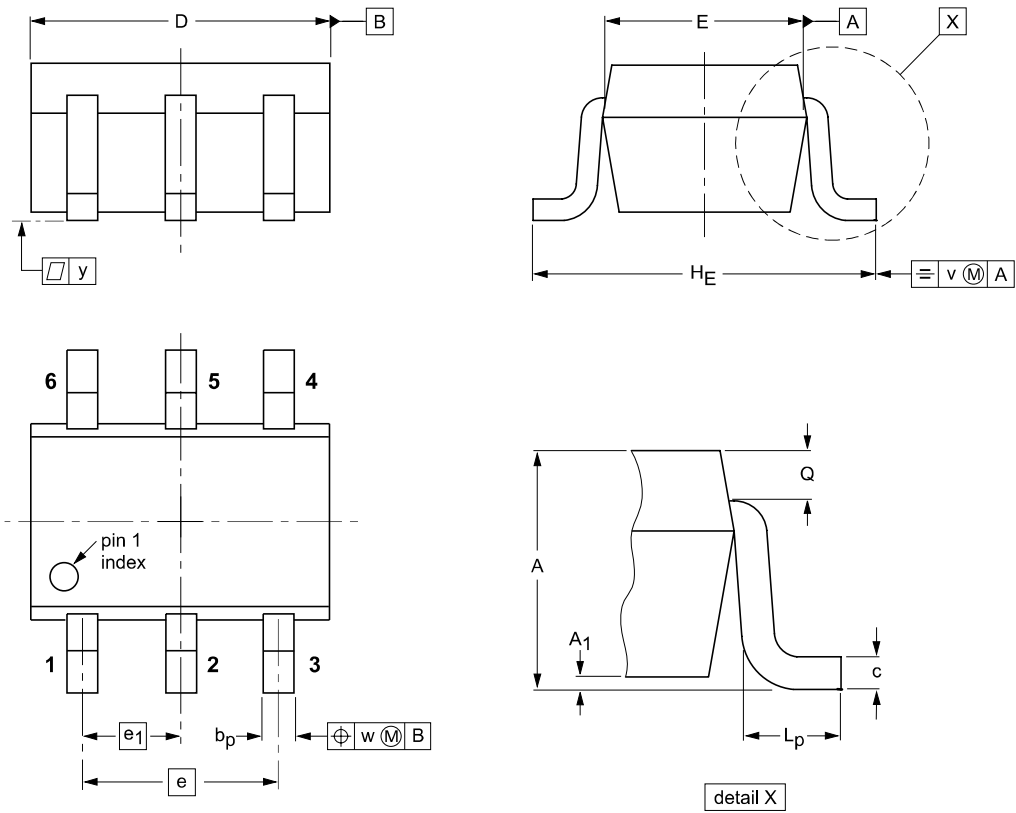

Figure 12. Current-Gain - Bandwidth Product

Package Outline

SOT-363



DIMENSIONS (mm are the original dimensions)

UNIT	A	A ₁ max	b _p	c	D	E	e	e ₁	H _E	L _p	Q	v	w	y
mm	1.1 0.8	0.1	0.30 0.20	0.25 0.10	2.2 1.8	1.35 1.15	1.3	0.65	2.2 2.0	0.45 0.15	0.25 0.15	0.2	0.2	0.1

Summary of Packing Options

Package	Package Description	Packing Quantity	Industry Standard
SOT-363	Tape/Reel, 7" reel	3000	EIA-481-1