

1 Channel Ultra-low Capacitance ESD Protection

Features

- ◆Ultra-Low capacitance:0.05pF(typ.)
- ◆Low leakage current(<100nA)
- ◆Fast response time(<1ns)
- ◆Bi-directional,single line protection
- ◆IEC 61000-4-2 (ESD Air): 15kV
- IEC 61000-4-2 (ESD Contact): 8kV

Application

- ◆USB 3.0/3.1
- ◆HDMI 1.3/1.4/2.0
- ◆RF Antenna
- ◆SATA and eSATA Interface

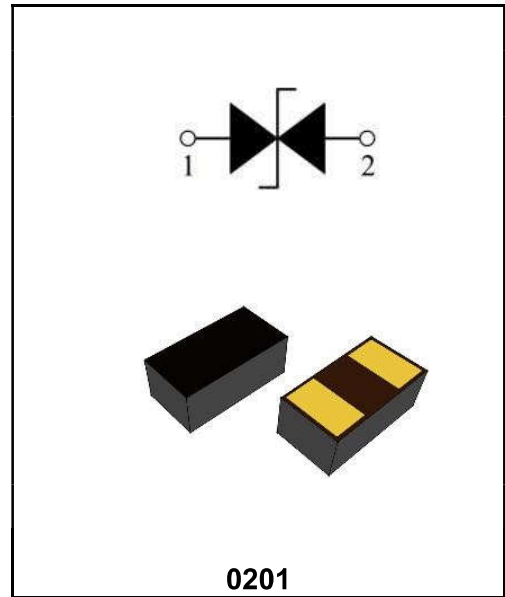

Order Information

Part Number	Package	Size (mm)	Delivery Form	Delivery Quantity
PESD0201B15	0201	0.60x0.30x0.32	7" T&R	15000PCS/Tape

Limiting Values(TA = 25 °C, unless otherwise specified)

Symbol	Parameter	Conditions	Min	Max	Unit
VESD	Electrostatic Discharge Voltage	IEC 61000-4-2; Contact Discharge	-	8	kV
		IEC 61000-4-2; Air Discharge	-	15	kV
TA	Operating Temperature Range	-	-40	90	°C
Tstg	Storage Temperature Range	-	-55	125	°C

Electrical Characteristics(TA = 25 °C unless otherwise specified)

Symbol	Parameter	Conditions	Min	Typ.	Max	Unit
VDC	Continuous Operating Voltage	-	-	-	15.0	V
VT	Trigger Voltage	IEC61000-4-2 8kV contactdischarge	-	450	-	V
VC	Clamping Voltage	IEC61000-4-2 8kV contactdischarge	-	40	-	V
IL	Leakage Current	DC 15 V shall be appliedon mponent	-	-	100	nA
CJ	Capacitance	Measured at 10MHz	-	0.05	-	pF

Typical Characteristics

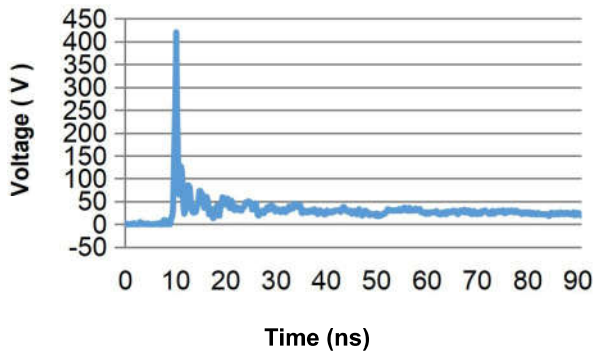

Fig.1 Typical ESD Response (IEC 61000-4-2, 8kV contact discharge)

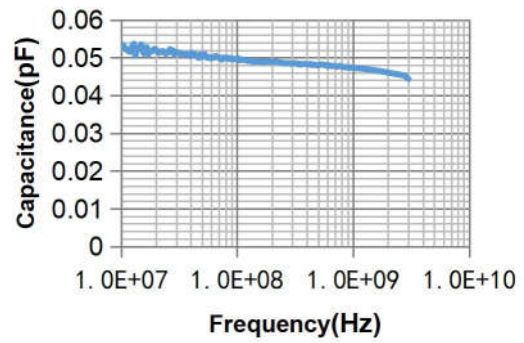

Fig.2 Typical Device Capacitance VS. Frequency

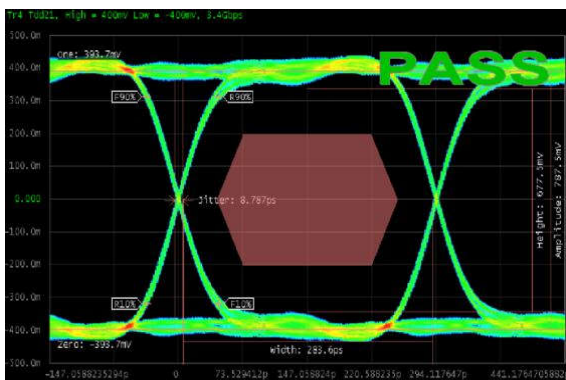

Fig.3 HDMI 1.4 Mask at 3.4 Gbps

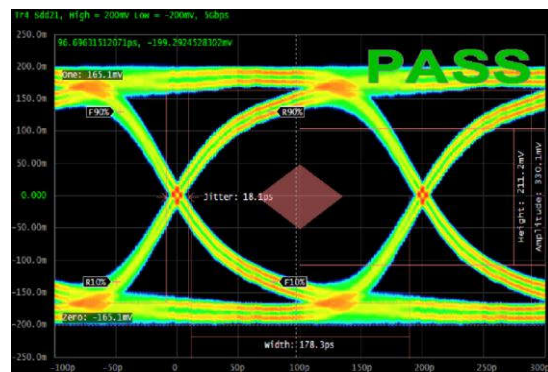

Fig.4 USB 3.0 Mask at 5.0 Gbps

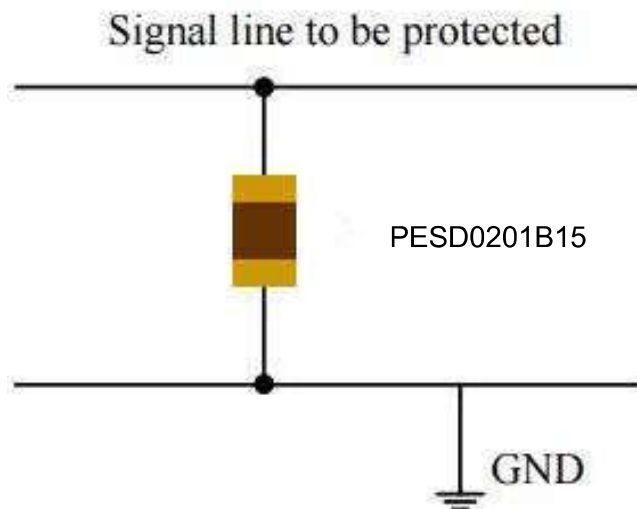
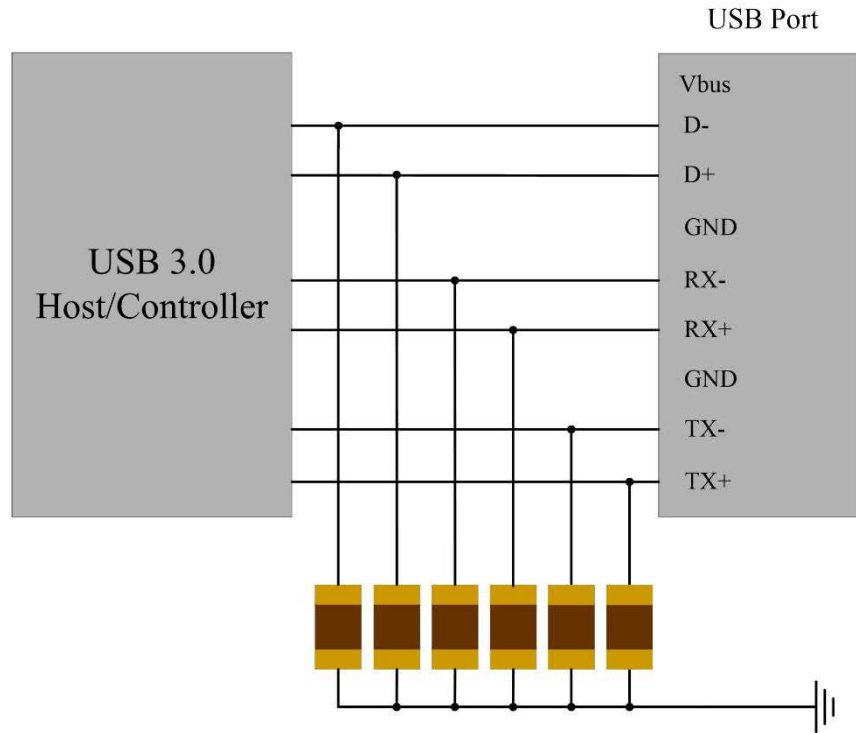

Fig.5 HDMI 2.0 Mask at 6.0 Gbps

ESD Protection for Signal Line

The PESD is designed for the protection of one bidirectional data line from ESD damage.

1. Place the PESD as close to the input terminal or connector as possible.
2. Minimize the path length between the PESD and the protected signal line.
3. Use ground planes whenever possible.



Package Dimension

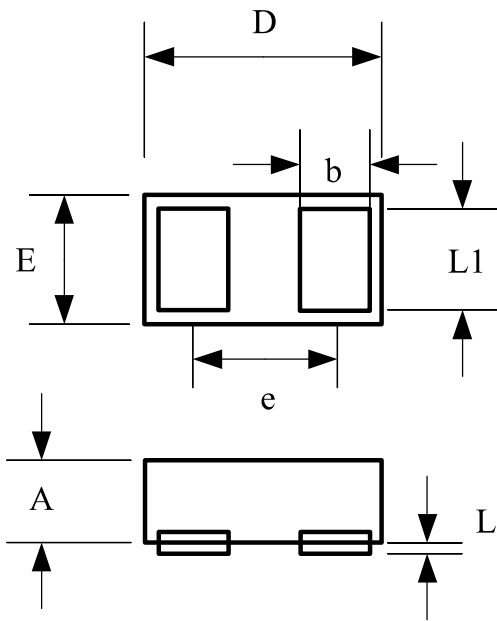

Recommended Solder Pad Footprint

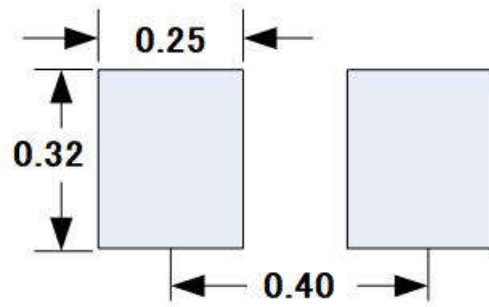

*Sizes in mm

Notes:

L2 This solder pad layout is for reference purposes only.

Dimension	Unit: Millimeters	
	Min.	Max.
A	0.25	0.40
b	0.14	0.24
D	0.50	0.70
E	0.25	0.35
e	0.38BSC	
L1	0.20	0.30
L2	0.00	0.05

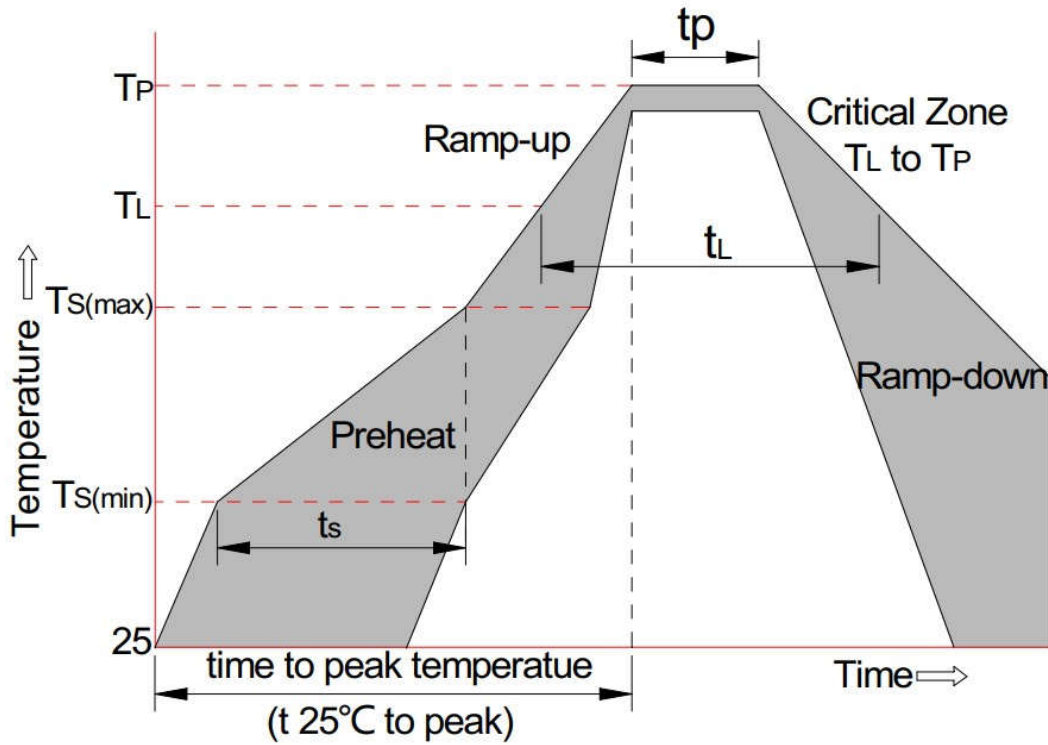

Reflow Condition		Pb-Free Assembly
Pre-heat	-Temperature Min (Ts(min))	+150°C
	-Temperature Max(Ts(max))	+200°C
	-Time (Min to Max) (ts)	60-180 secs.
Average ramp up rate (Liquid us Temp (TL) to peak)		3°C/sec. Max
Ts(max) to TL - Ramp-up Rate		3°C/sec. Max
Reflow	-Temperature(TL)(Liquid us)	+217°C
	-Temperature(tL)	60-150 secs.
Peak Temp (Tp)		+260(+0/-5)°C
Time within 5°C of actual Peak Temp (tp)		30 secs. Max
Ramp-down Rate		6°C/sec. Max
xTime 25°C to Peak Temp (TP)		8 min. Max
Do not exceed		+260°C