

1 Channel Ultra-low Capacitance ESD Protection

Features

- ◆Ultra-Low capacitance:0.05pF(typ.)
- ◆Low leakage current(<100nA)
- ◆Fast response time(<1ns)
- ◆Bi-directional,single line protection
- ◆IEC 61000-4-2 (ESD Air): 15kV
- IEC 61000-4-2 (ESD Contact): 8kV

Application

- ◆USB 3.0/3.1
- ◆HDMI 1.3/1.4/2.0
- ◆RF Antenna
- ◆SATA and eSATA Interface

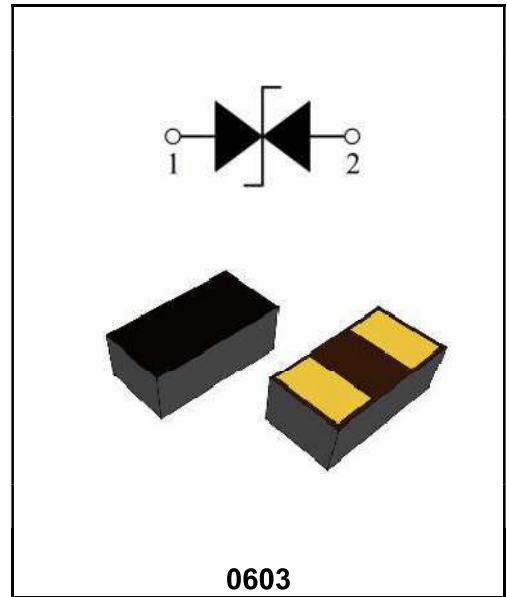

Order Information

Part Number	Package	Size (mm)	Delivery Form	Delivery Quantity
PESD0603B05	0603	1.60X0.80X0.40	7" T&R	5000PCS/Tape

Limiting Values(TA = 25 °C, unless otherwise specified)

Symbol	Parameter	Conditions	Min	Max	Unit
VESD	Electrostatic Discharge Voltage	IEC 61000-4-2; Contact Discharge	-	8	kV
		IEC 61000-4-2; Air Discharge	-	15	kV
TA	Operating Temperature Range	-	-40	90	°C
Tstg	Storage Temperature Range	-	-55	125	°C

Electrical Characteristics(TA = 25 °C unless otherwise specified)

Symbol	Parameter	Conditions	Min	Typ.	Max	Unit
VDC	Continuous Operating Voltage	-	-	-	5.0	V
VT	Trigger Voltage	IEC61000-4-2 8kV contact discharge	-	450	-	V
VC	Clamping Voltage	IEC61000-4-2 8kV contact discharge	-	40	-	V
IL	Leakage Current	DC 5 V shall be applied on component	-	-	100	nA
CJ	Capacitance	Measured at 10MHz	-	0.05	-	pF

Typical Characteristics

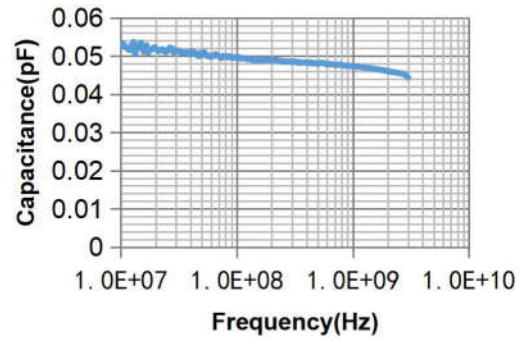
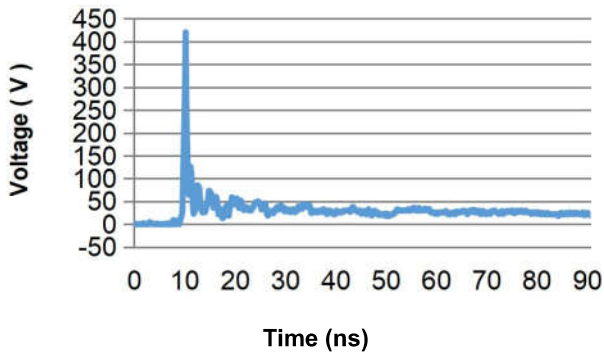

ESD Protection for Signal Line

The PESD is designed for the protection of one bidirectional data line from ESD damage.

1. Place the PESD as close to the input terminal or connector as possible.
2. Minimize the path length between the PESD and the protected signal line.
3. Use ground planes whenever possible.

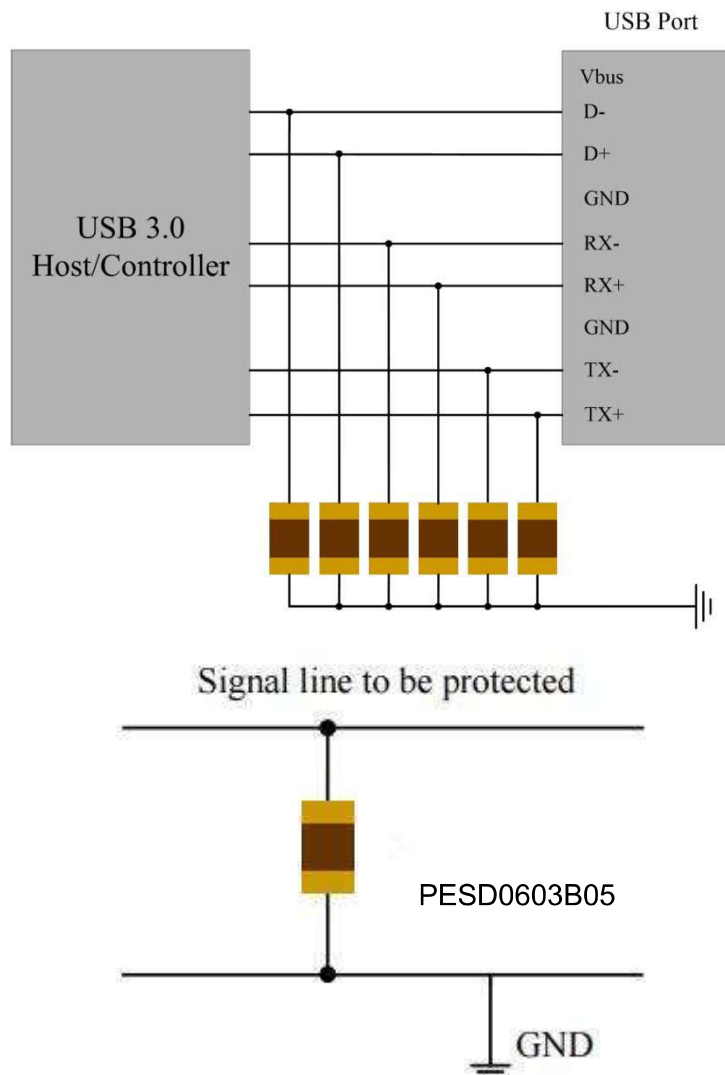

Package Dimension

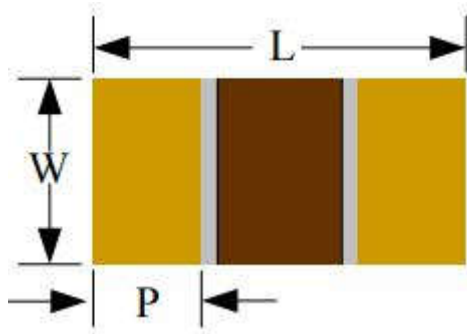

Recommended Solder Pad Footprint

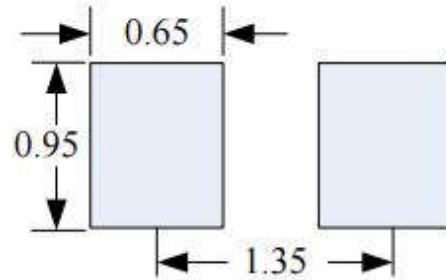

***Sizes in mm**

Notes:

This solder pad layout is for reference purposes only.

Dimension	Unit: Millimeters	
	Min.	Max.
L	1.45	1.75
W	0.70	0.95
P	0.20	0.50
H	0.26	0.46

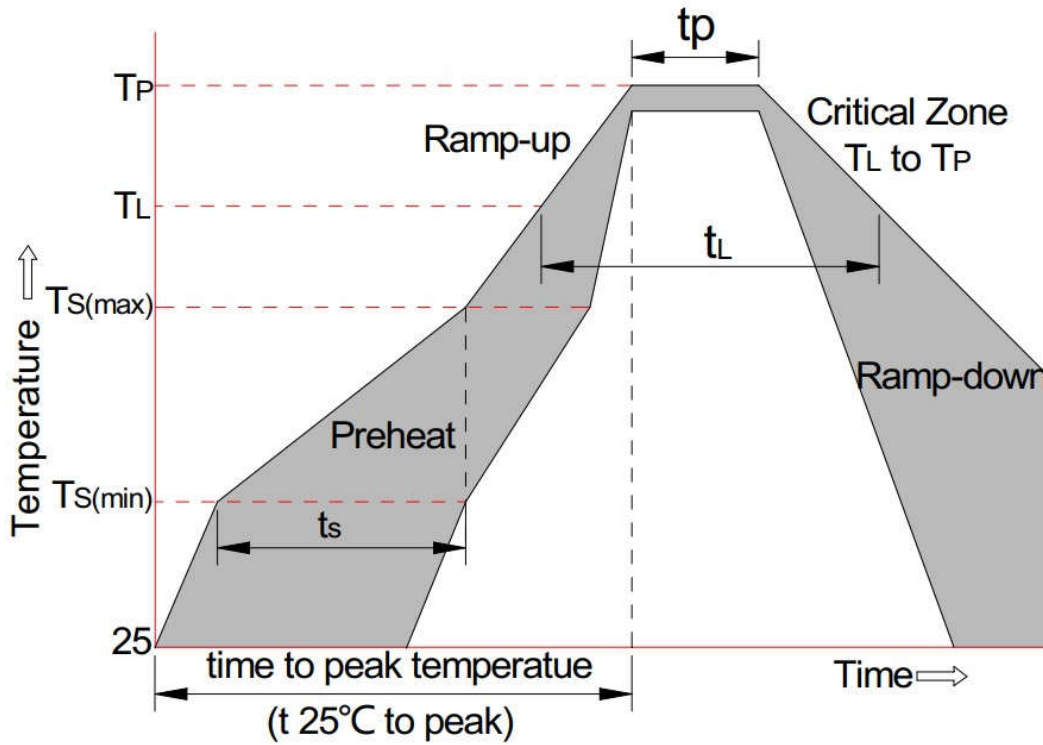

Reflow Condition		Pb-Free Assembly
Pre-heat	-Temperature Min ($T_{s(min)}$)	+150°C
	-Temperature Max($T_{s(max)}$)	+200°C
	-Time (Min to Max) (t_s)	60-180 secs.
Average ramp up rate (Liquid us Temp (T_L) to peak)		3°C/sec. Max
$T_{s(max)}$ to T_L - Ramp-up Rate		3°C/sec. Max
Reflow	-Temperature(T_L)(Liquid us)	+217°C
	-Temperature(t_L)	60-150 secs.
Peak Temp (T_p)		+260(+0/-5)°C
Time within 5°C of actual Peak Temp (t_p)		30 secs. Max
Ramp-down Rate		6°C/sec. Max
xTime 25°C to Peak Temp (T_P)		8 min. Max
Do not exceed		+260°C