

Transient Voltage Suppressor

APPLICATIONS

- ◆Laptop Computers
- ◆Cellular Phones
- ◆Digital Cameras
- ◆Personal Digital Assistant (PDA_S)

IEC COMPATIBILITY (EN61000-4)

- ◆61000-4-2 (ESD): Air±15kV, Contact ±8kV
- ◆61000-4-4 (EFT): 40A - 5/50ns
- ◆61000-4-5 (Lightning) 6A (8/20µs)

FEATURES

- 500 Watts Peak Pulse Power per Line (tp = 8/20µs)
- Protects one I/O or power line
- Working Voltage: 24V
- Low Leakage Current
- Response Time is Typically < 1 ns

MECHANICAL DATA

- ◆Case:SOD-323
- ◆Terminals: Solderable per MIL-STD-750, Method 2026
- ◆Approx.Weight:5.48mg/0.00019oz

Pinning

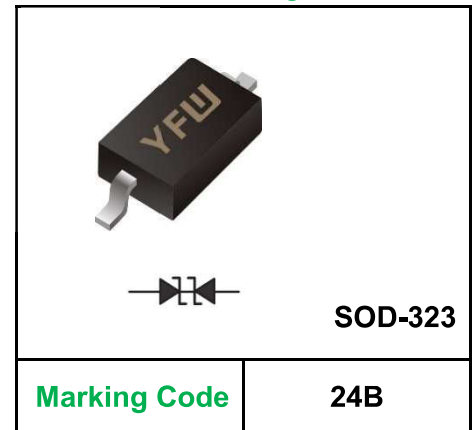

ElectronicsParameter

Parameter	Symbol
MaximumReversePeakPulseCurrent	I_{PP}
ClampingVoltage@Ipp	V_C
PeakReverseWorkingVoltage	V_{RWM}
ReverseLeakageCurrent @VRWM	I_R
BreakdownViltage@IT	V_{BR}
TestCurrent	I_T
ForwardCurrent	I_F
ForwardVoltage@IF	V_F

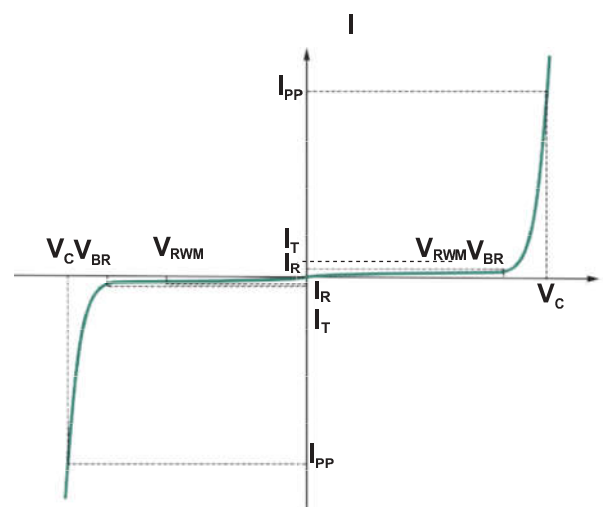

AbsoluteMaximumRating

Rating	Symbol	Value	Unit
PeakPulsePower(tp=8/20us)	PPP	500	W
PeakForwardVoltage(IF=1A,tp=8/20μs)	V _{FP}	1.3	V
OperatingJunctionTemperature	T _J	-55to+125	°C
StorageTemperature	T _{STG}	-55to+150	°C

ElectricalCharacteristics(Tamb=25°C)

Parameter	Symbol	Conditions	Minimum	Typical	Maximum	Units
ReverseStand-OffVoltage	VRWM				24.0	V
ReverseBreakdownVoltage	VBR	IT=1mA	26.7			V
ReverseLeakageCurrent	IR	VRWM=24V,Ta=25°C			1.0	uA
ClampingVoltage	VC	IPP=6A,tp=8/20us		37	40	V
JunctionCapacitance	Cj	VR=0V,f=1HMz		20	25	pF

Fig.1 Non-Repetitive Peak Pulse Power vs. Pulse Time

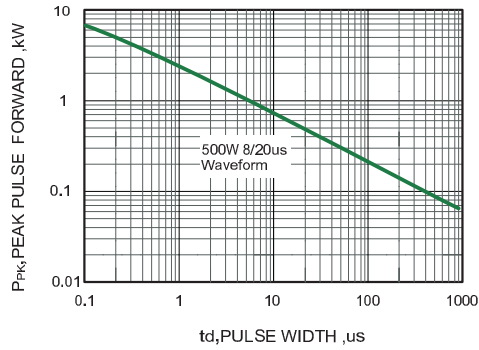

Fig.2 Forward Current Derating Curve

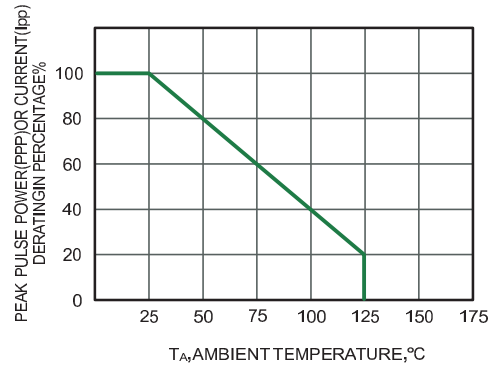

Fig.3 Clamping Voltage vs. Peak Pulse Current

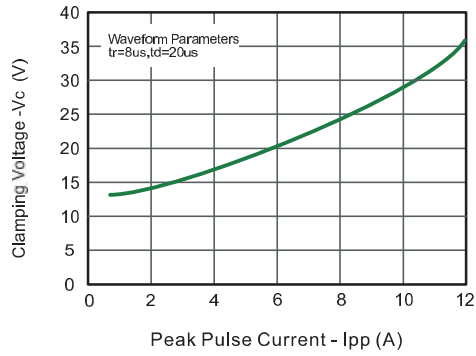

Fig.4 Power Derating Curve

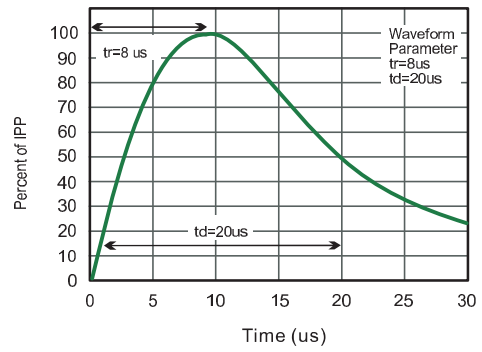
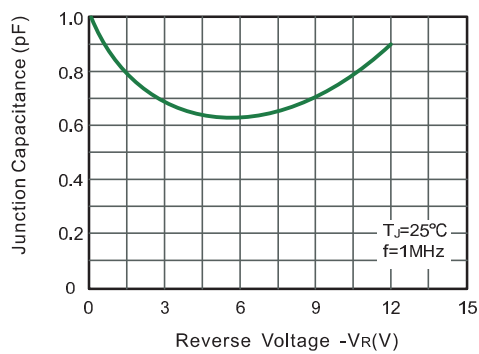
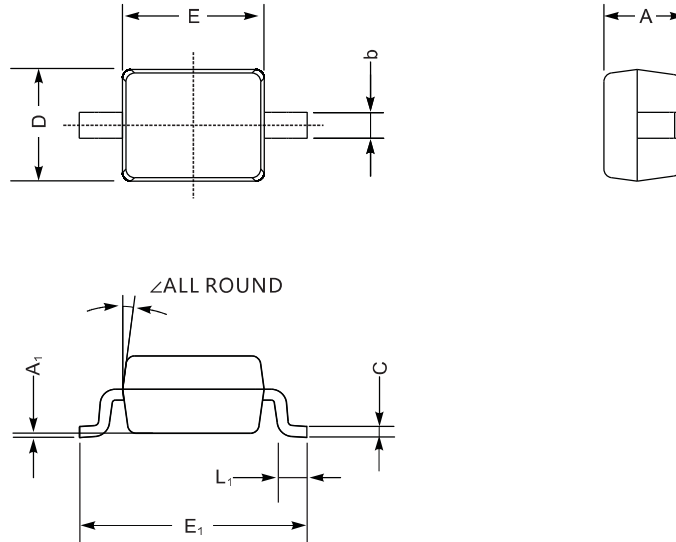

Fig.5 Typical Junction Capacitance



Package Outline SOD-323

Plastic surface mounted package; 2 leads



UNIT		A	C	D	E	E ₁	b	L ₁	A ₁	∠
mm	max	1.1	0.15	1.4	1.8	2.75	0.4	0.45	0.2	9°
	min	0.8	0.08	1.2	1.4	2.55	0.25	0.2	—	
mil	max	43	5.9	55	70	108	16	16	8	
	min	32	3.1	47	63	100	9.8	7.9	—	

The recommended mounting pad size

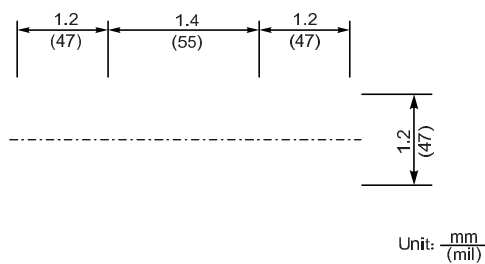

Summary of Packing Options

Package	Packing Description	Packing Quantity	Industry Standard
SOD-323	Tape/Reel, 7" reel	3000	EIA-481-1