

Switching Diodes
FEATURES

- ◆ For surface mounted applications
- ◆ Glass Passivated Chip Junction
- ◆ Fast reverse recovery time
- ◆ Ideal for automated placement
- ◆ Lead free in comply with EU RoHS 2011/65/EU directives

MECHANICAL DATA

- ◆ Case: SOD-123
- ◆ Terminals: Solderable per MIL-STD-750, Method 2026
- ◆ Approx. Weight: 16mg / 0.00056oz

Absolute Maximum Ratings at 25 °C

Parameter	Symbols	1N4148W	Units
Maximum Repetitive Peak Reverse Voltage	V_{RRM}	100	V
Maximum RMS voltage	V_{RMS}	75	V
Continuous Forward Current	I_F	300	mA
Non-reptitive Peak Forward Surge Current at 1ms	I_{FSM}	4	A
Total Power Dissipation	P_{tot}	400	mW
Operating and Storage Temperature Range	T_j, T_{stg}	-55 ~ +150	°C

Characteristics at $T_a = 25\text{ °C}$

Parameter	Symbols	1N4148W	Units	
Reverse Breakdown Voltage at $I_R = 1\mu A$	$V_{(BR)R}$	75	V	
Maximum Forward Voltage	V_F	at 1 mA	0.715	V
		at 10 mA	0.855	
		at 50 mA	1.00	
		at 150 mA	1.25	
		at 300 mA	1.50	
Peak Reverse Current	I_R	at $V_R = 20V, T_j = 25\text{ °C}$	0.025	uA
		at $V_R = 75V, T_j = 25\text{ °C}$	1	
		at $V_R = 25V, T_j = 150\text{ °C}$	30	
		at $V_R = 75V, T_j = 150\text{ °C}$	50	
Typical Junction Capacitance $f = 1MHz, V_R = 4V$	C_j	5	pF	
Maximum Reverse Recovery Time	T_{rr} Typical	4	nS	

(1) Measured with $I_F = 0.5 A, I_R = 1 A, I_{rr} = 0.25 A$

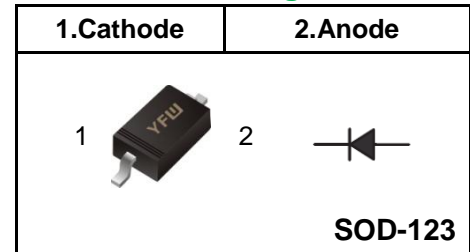
Pinning

Marking Code

1N4148W	T4
---------	----

Fig.1 Power Derating Curve

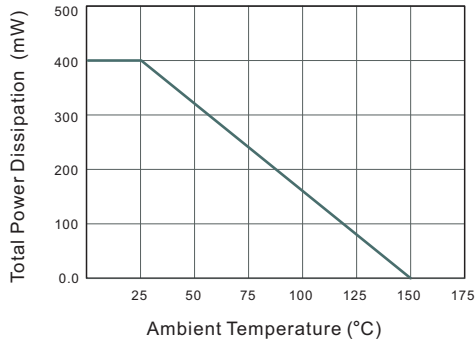

Fig.2 Typical Reverse Characteristics

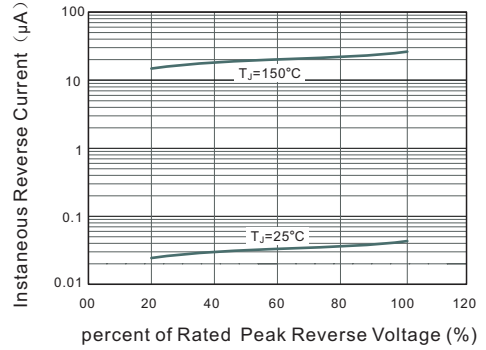

Fig.3 Typical Instantaneous Forward Characteristics

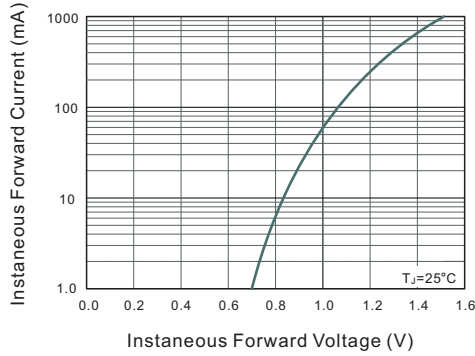
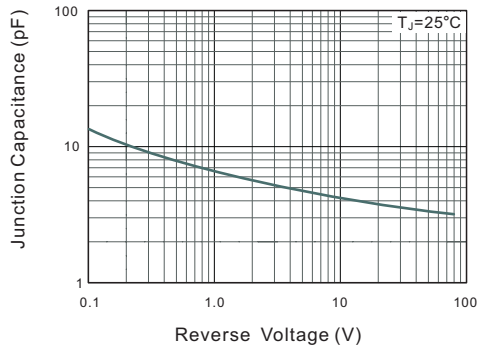
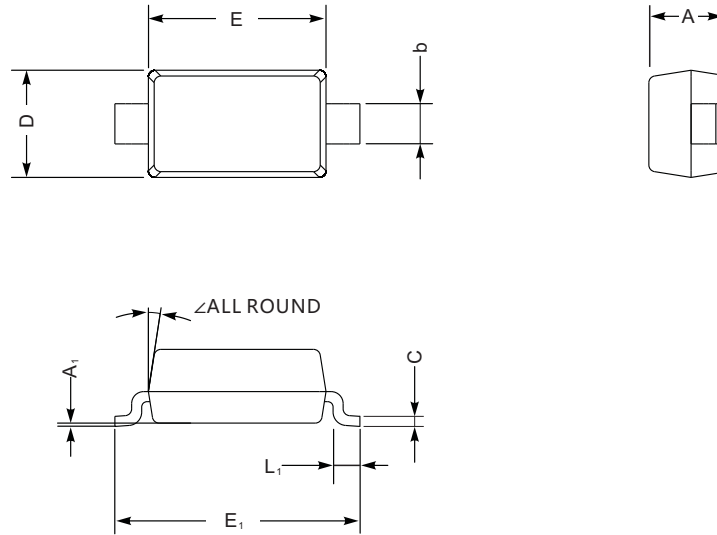

Fig.4 Typical Junction Capacitance



Package Outline SOD-123

Plastic surface mounted package; 2 leads



UNIT		A	C	D	E	E ₁	L ₁	b	A ₁	∠
mm	max	1.3	0.22	1.8	2.8	3.9	0.45	0.7	0.2	9°
	min	0.9	0.09	1.5	2.5	3.6	0.25	0.5	—	
mil	max	51	8.7	71	110	154	18	28	8	
	min	35	3.5	59	98	142	10	20	—	

The recommended mounting pad size

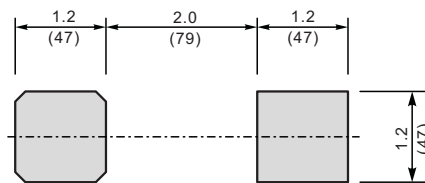

Unit: $\frac{\text{mm}}{\text{mil}}$

Summary of Packing Options

Package	Packing Description	Packing Quantity	Industry Standard
SOD-123	Tape/Reel, 7" reel	3000	EIA-481-1