

Switching Diodes

FEATURES

- ◆ For surface mounted applications
- ◆ Glass Passivated Chip Junction
- ◆ Fast reverse recovery time
- ◆ Ideal for automated placement
- ◆ Lead free in comply with EU RoHS 2011/65/EU directives

MECHANICAL DATA

- ◆ Case: SOD-123
- ◆ Terminals: Solderable per MIL-STD-750, Method 2026
- ◆ Approx. Weight: 16mg / 0.00056oz

Pinning

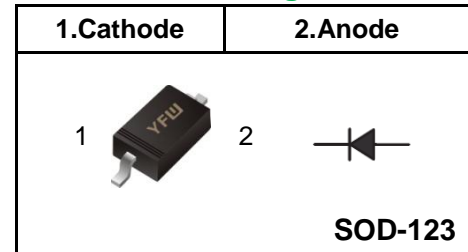

Marking Code

BAV19W	A8
BAV20W	T2
BAV21W	T3

Absolute Maximum Ratings at 25 °C

Parameter	Symbols	BAV19W	BAV20W	BAV21W	Units
Maximum Repetitive Peak Reverse Voltage	V_{RRM}	120	200	250	V
Maximum RMS voltage	V_{RMS}	100	150	200	V
Continuous Forward Current	I_F	250			mA
Repetitive Peak Forward Current	I_{FRM}	625			mA
Non-reptitive Peak Forward Surge Current	at 1s	1			A
	at 1ms	3			
	at 1us	9			
Total Power Dissipation	P_{tot}	500			mW
Operating and Storage Temperature Range	T_j, T_{stg}	-55 ~ +150			°C

Characteristics at Ta = 25 °C

Parameter	Symbols	BAV19W	BAV20W	BAV21W	Units
Reverse Breakdown Voltage at $I_R=100\mu A$	$V_{(BR)R}$	120	200	250	V
Maximum Forward Voltage	at 100 mA	1.00			V
	at 200 mA	1.25			
Maximum DC Reverse Current at Rated DC Blocking Voltage	$T_a=25^\circ C$	0.1			uA
	$T_a=150^\circ C$	100			
Typical Junction Capacitance at $V_R=4V, f=1MHz$	C_j	5			pF
Maximum Reverse Recovery Time	T_{rr}	50			nS

(1) Measured with $I_F = 0.5 A, I_R = 1 A, I_{rr} = 0.25 A$

Fig.1 Forward Current Derating Curve

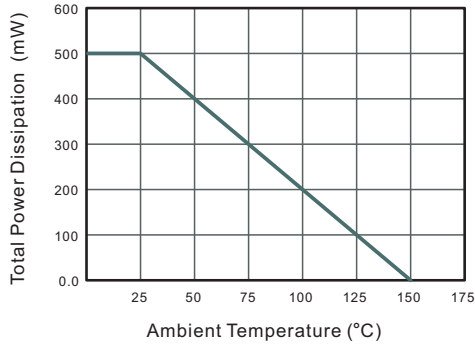

Fig.2 Typical Reverse Characteristics

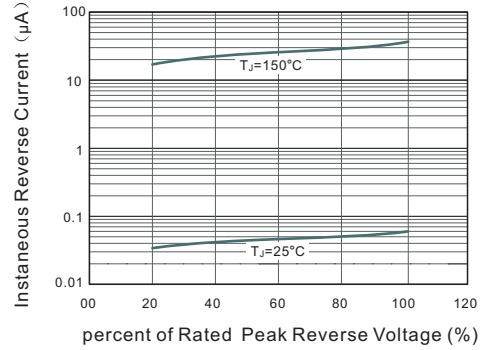

Fig.3 Typical Instantaneous Forward Characteristics

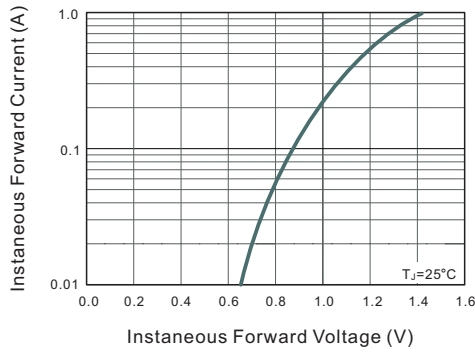
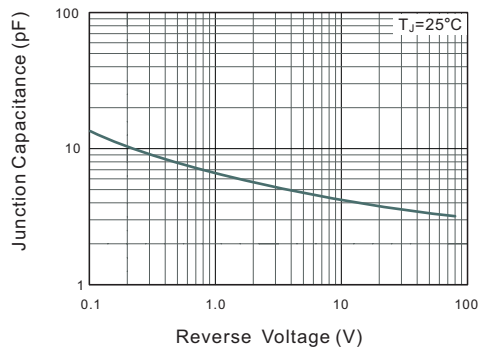
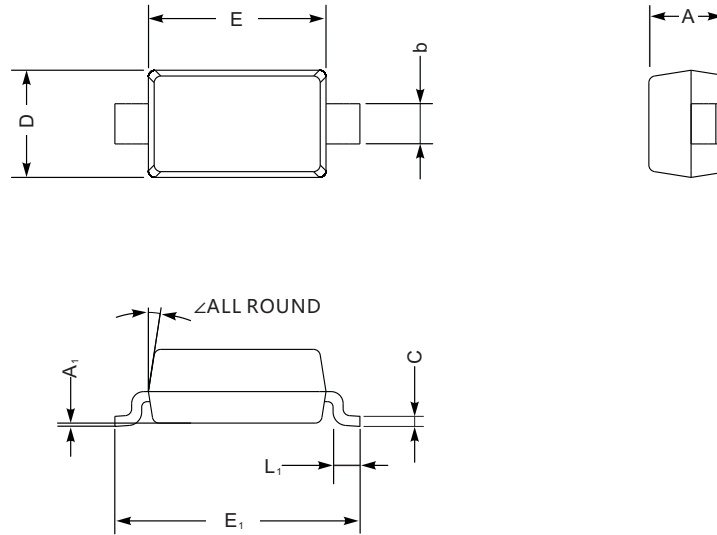

Fig.4 Typical Junction Capacitance



Package Outline SOD-123

Plastic surface mounted package; 2 leads



UNIT		A	C	D	E	E ₁	L ₁	b	A ₁	∠
mm	max	1.3	0.22	1.8	2.8	3.9	0.45	0.7	0.2	9°
	min	0.9	0.09	1.5	2.5	3.6	0.25	0.5	—	
mil	max	51	8.7	71	110	154	18	28	8	
	min	35	3.5	59	98	142	10	20	—	

The recommended mounting pad size

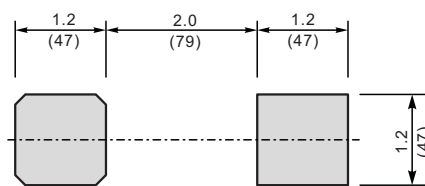

Unit: $\frac{\text{mm}}{\text{mil}}$

Summary of Packing Options

Package	Packing Description	Packing Quantity	Industry Standard
SOD-123	Tape/Reel, 7" reel	3000	EIA-481-1