

**12A 3Quadrants TRIACs**

**Product Summary**

Symbol	Value	Unit
$I_{T(AV)}$	12	A
$V_{DRM} V_{RRM}$	600/800	V
$V_{TM}$	1.55	V

**Features**

With high ability to withstand the shock loading of large current, With high commutation performances, 3 quadrants products especially recommended for use on inductive load.

**Application**

Washing machine, vacuums, massager, solid state relay, AC Motor speed regulation and so on.

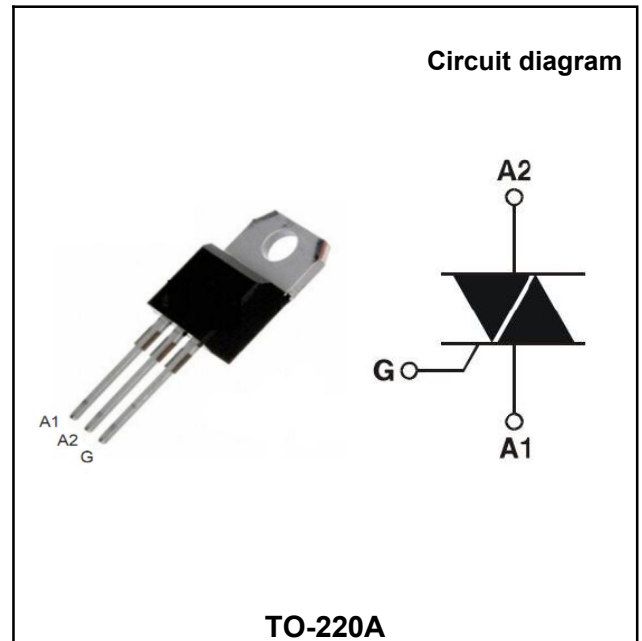

**Order Information**

Part Number	Package	Marking	Packing	Packing Quantity
BTA12	TO-220A	BTA12 800CW XXXX	box	1000PCS/box

**Absolute maximum ratings (Ta=25°C unless otherwise noted)**

Parameter	Symbol	Value	Unit
Repetitive peak off-state voltage	$V_{DRM}$	600/800	V
Repetitive peak reverse voltage	$V_{RRM}$	600/800	V
RMS on-state current	$I_T(RMS)$	12	A
Non repetitive surge peak on-state current (full cycle, F=50Hz)	$I_{TSM}$	120	A
I <sup>2</sup> t value for fusing (tp=10ms)	I <sup>2</sup> t	78	A <sup>2</sup> s
Critical rate of rise of on-state current (IG =2 x IG T)	di/dt	I - II - III   50	A/μs
Peak gate current	IGM	4	A
Average gate power dissipation	PG (AV)	1	W
Junction Temperature	TJ	-40 ~+125	°C
Storage Temperature	TSTG	-40 ~+150	°C

**Electrical characteristics (TA=25°C, unless otherwise noted)**

Parameter	Symbol	Test Condition	Value		Unit	
			SW	CW		
Gate trigger current	$I_{GT}$	$V_D=12V$ $R_L=33\Omega$ $T_J=25^\circ C$	$I-II-III$	$\leq 10$	$\leq 35$	<b>mA</b>
Gate trigger voltage	$V_{GT}$	$I-II-III$	$\leq 1.3$		<b>V</b>	
Gate non-trigger voltage	$V_{GD}$	$V_D = V_{DRM} T_J=125^\circ C$	$\geq 0.2$		<b>V</b>	
latching current	$I_L$	$I_G=1.2I_{GT}$	I-III	$\leq 25$	$\leq 50$	<b>mA</b>
			II	$\leq 30$	$\leq 60$	
Holding current	$I_H$	$I_T = 100mA$	$\leq 15$	$\leq 35$	<b>mA</b>	
Critical-rate of rise of commutation voltage	$dV_D/dt$	$V_D=2/3V_{DRM}$ Gate Open $T_J=125^\circ C$	$\geq 40$	$\geq 500$	<b>V/<math>\mu s</math></b>	

**STATIC CHARACTERISTICS**

Forward "on" voltage	$V_{TM}$	$I_{TM} = 17A$ $t_p=380\mu s$	$\leq 1.55$	<b>V</b>	
Repetitive Peak Off-State Current	$I_{DRM}$	$V_D=V_{DRM} V_R=V_{RRM}$	$T_J=25^\circ C$	$\leq 5$	<b><math>\mu A</math></b>
Repetitive Peak Reverse Current	$I_{RRM}$		$T_J=125^\circ C$	$\leq 1$	<b>mA</b>

**THERMAL RESISTANCES**

Thermal resistance	$R_{th(j-c)}$	Junction to case(AC)	2.3	<b><math>^\circ C/W</math></b>
	$R_{th(j-a)}$	Junction to ambient	60	<b><math>^\circ C/W</math></b>

**Ordering Information**

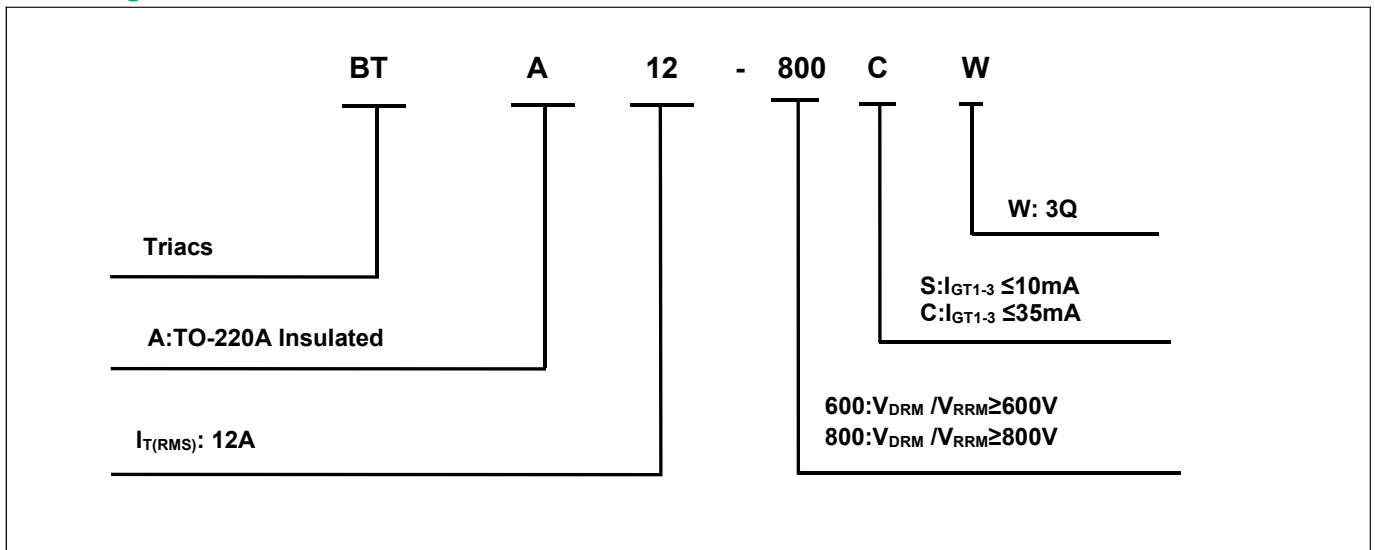

Typical Characteristics

FIG.1: Maximum power dissipation versus RMS on-state current (full cycle)

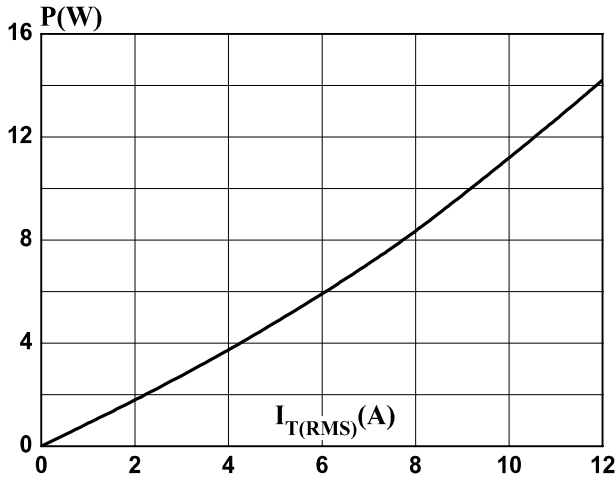

FIG.3: Surge peak on-state current versus number of cycles

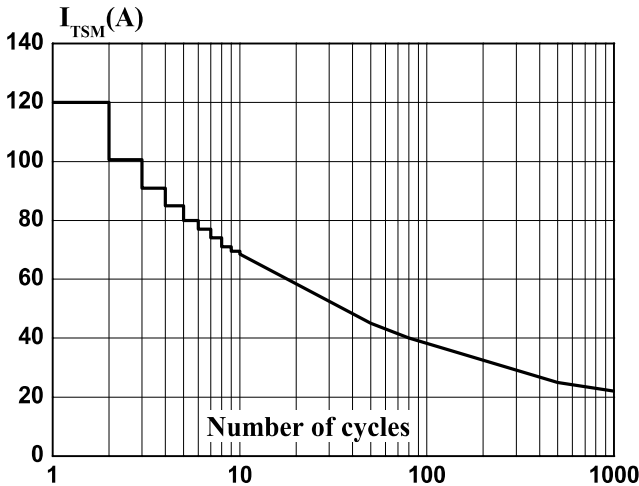

FIG.5: Non-repetitive surge peak on-state current for a sinusoidal pulse with width  $t_p < 10\text{ms}$

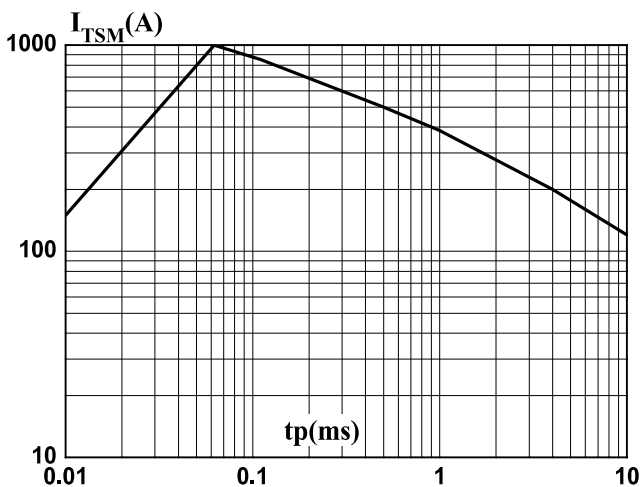

FIG.2: RMS on-state current versus case temperature (full cycle)

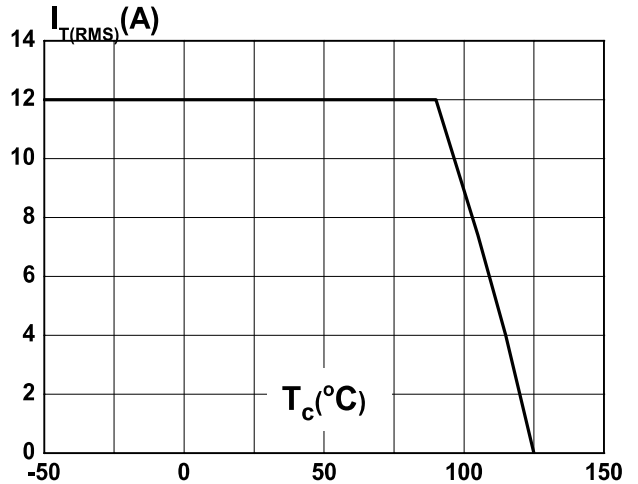

FIG.4: On-state characteristics (maximum values)

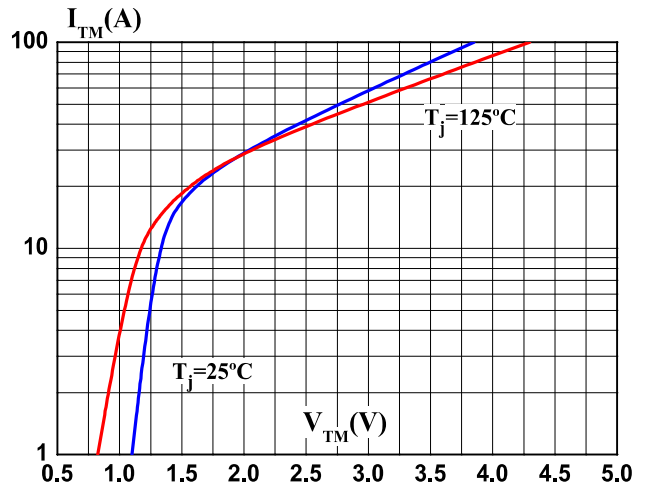
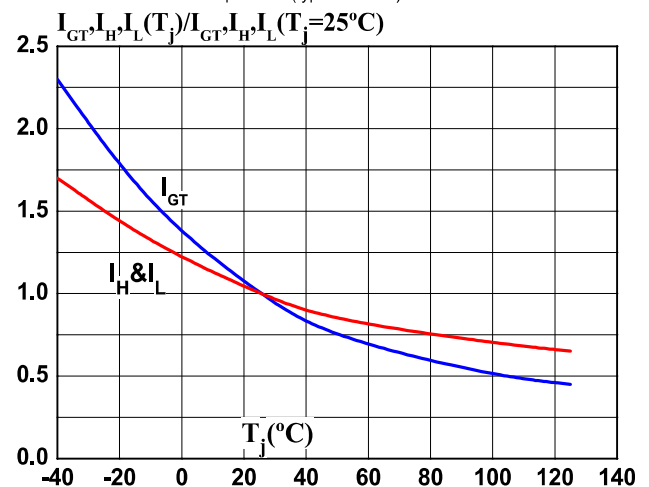
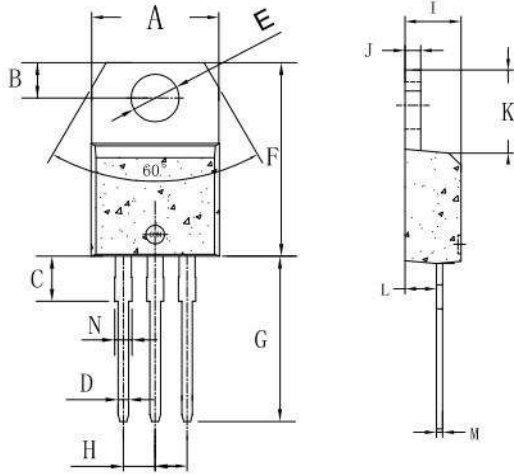

FIG.6: Relative variations of gate trigger current, holding current and latching current versus junction temperature (typical values)



Package Information

TO-220A



Symbol	Dimensions In Millimeters		Dimensions In Inches	
	Min	Max	Min	Max
A	9.8	10.4	0.385	0.409
B	2.65	3.1	0.104	0.122
C	2.8	4.2	0.110	0.165
D	0.7	0.92	0.027	0.036
E	3.75	3.95	0.147	0.155
F	14.8	16.1	0.582	0.633
G	13.05	13.6	0.513	0.535
H	2.4	2.7	0.094	0.106
I	4.38	4.61	0.172	0.181
J	1.15	1.36	0.045	0.053
K	5.85	6.82	0.230	0.268
L	2.35	2.75	0.092	0.108
M	0.35	0.65	0.013	0.025
N	1.18	1.42	0.046	0.055