

12A Standard SCRs

Product Summary

Symbol	Value	Unit
$I_{T(RMS)}$	12	A
$V_{DRM} V_{RRM}$	600/800	V
V_{TM}	1.55	V

Features

With high ability to withstand the shock loading of large current, Provide high dv/dt rate with strong resistance to electromagnetic interference.

Application

Power charger, T-tools, massager, solid state relay, AC Motor speed regulation and so on.

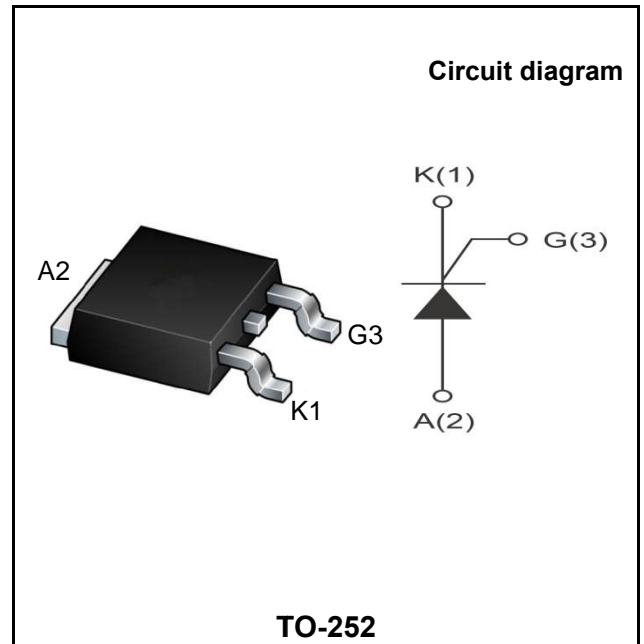

Order Information

Part Number	Package	Marking	Delivery Form	Delivery Quantity
BT151D	TO-252	BT151 600 XXXX	12" T&R	2500PCS/Tape

Absolute maximum ratings (Ta=25°C unless otherwise noted)

Parameter	Symbol	Value	Unit
Repetitive peak off-state voltage	V_{DRM}	600/800	V
Repetitive peak reverse voltage	V_{RRM}	600/800	V
RMS on-state current	$I_{T(RMS)}$	12	A
Non repetitive surge peak on-state current (full cycle, F=50Hz)	I_{TSM}	95	A
I^2t value for fusing (tp=10ms)	I^2t	45	A ² s
Critical rate of rise of on-state current ($I_G = 2 \times I_{GT}$)	di_T/dt	50	A/ μ s
Peak gate current	I_{GM}	4	A
Average gate power dissipation	$P_G (AV)$	1	W
Junction Temperature	T_J	-40~+125	°C
Storage Temperature	T_{STG}	-40 ~+150	°C

Electrical characteristics (TA=25°C, unless otherwise noted)

Parameter	Symbol	Test Condition	Value		Unit
			Min	Max	
Gate trigger current	I_{GT}	$V_D = 12V R_L = 140\Omega$	-	10	mA
Gate trigger voltage	V_{GT}		-	1.3	V
Gate non-trigger voltage	V_{GD}	$V_D = V_{DRM} T_j = 125^\circ C$	0.2	-	V
latching current	I_L	$I_G = 1.2I_{GT}$	-	50	mA
Holding current	I_H	$I_T = 50mA$	-	40	mA
Critical-rate of rise of commutation voltage	dV_D/dt	$V_D = 2/3V_{DRM}$ Gate Open $T_j = 125^\circ C$	200	-	V/μs

STATIC CHARACTERISTICS

Forward "on" voltage	V_{TM}	$I_{TM} = 16A$ $t_p = 380\mu s$	-	1.55	V	
Repetitive Peak Off-State Current	I_{DRM}	$V_D = V_{DRM} V_R = V_{RRM}$	$T_j = 25^\circ C$	-	5	μA
Repetitive Peak Reverse Current	I_{RRM}		$T_j = 125^\circ C$	-	2	mA

THERMAL RESISTANCES

Thermal resistance	$R_{th(j-c)}$	Junction to case	TYP.	1.3	$^\circ C/W$
	$R_{th(j-a)}$	Junction to ambient	TYP.	70	$^\circ C/W$

Ordering Information

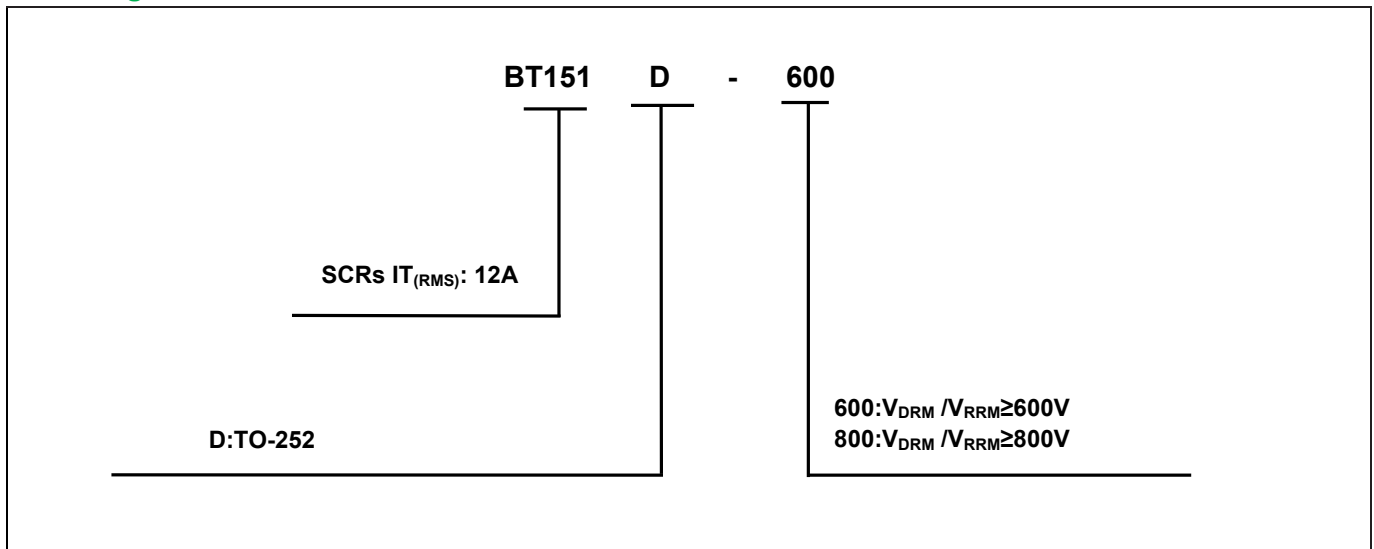

Typical Characteristics

FIG.1: Maximum power dissipation versus RMS on-state current (full cycle)

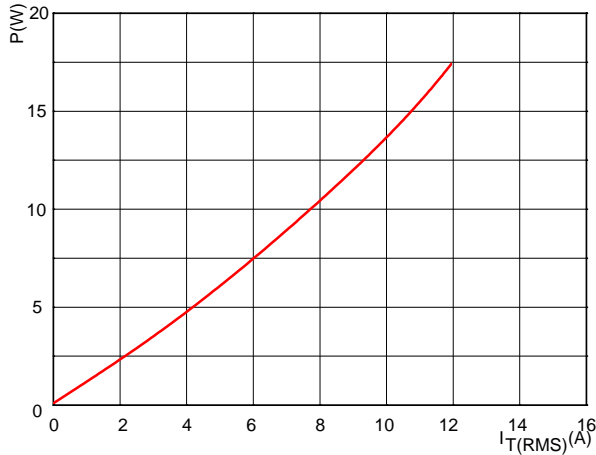

FIG.2: RMS on-state current versus case temperature (full cycle)

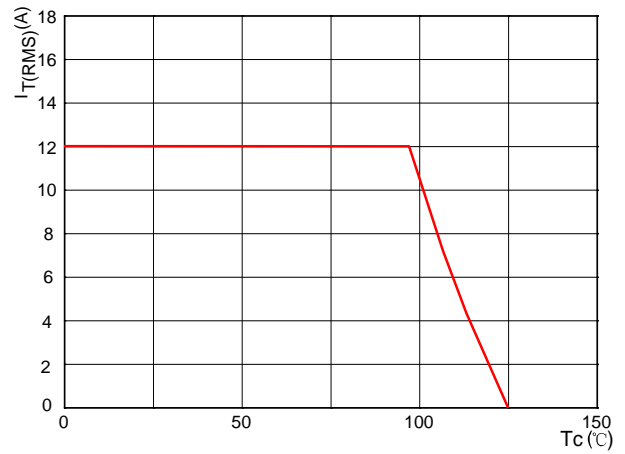

FIG.3: Surge peak on-state current versus number of cycles

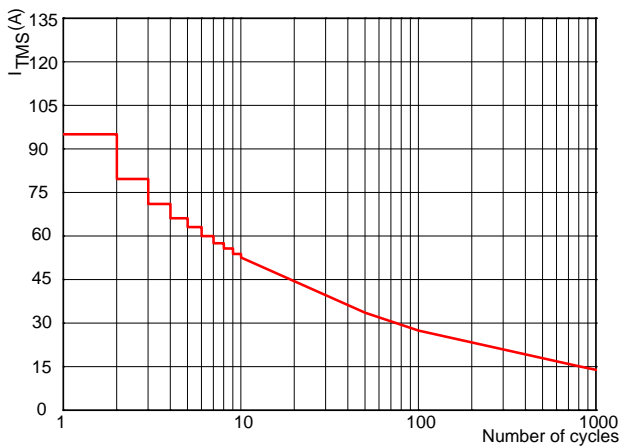

FIG.4: On-state characteristics (maximum values)

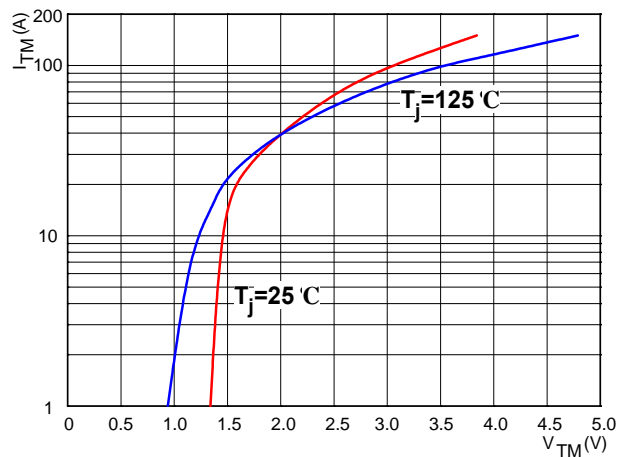

FIG.5: Non-repetitive surge peak on-state current for a sinusoidal pulse with width $t_p < 10\text{ms}$

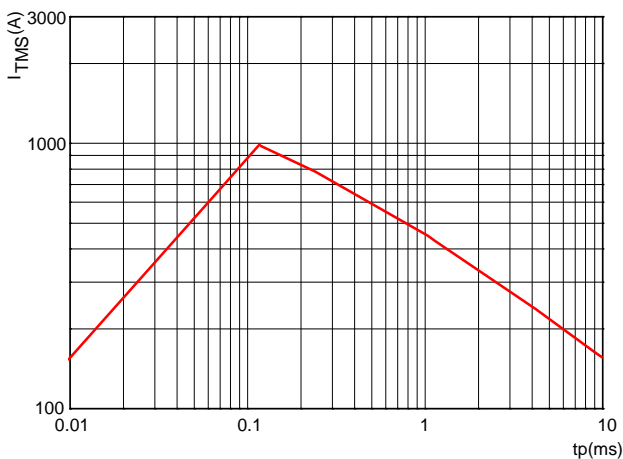
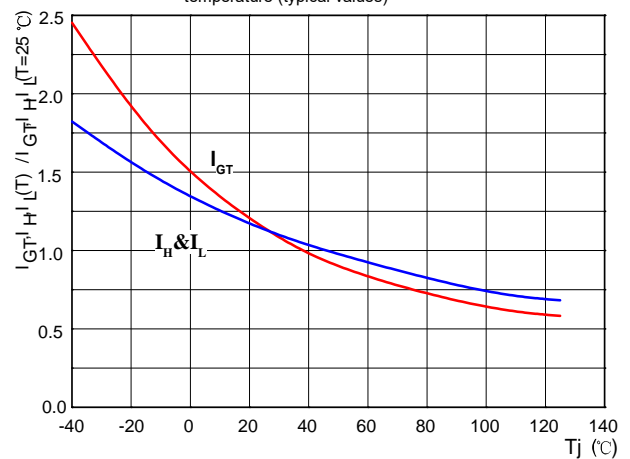

FIG.6: Relative variations of gate trigger current, holding current and latching current versus junction temperature (typical values)



Typical Characteristics

TO-252

