

■ **General Purpose Rectifier Applications**

■ **Features**

- Fast Switching Speed
- For General Purpose Switching Applications.
- High Conductance
- Surface Mount Package Ideally Suited for Automatic Insertion

■ **Marking**

Marking	T7
---------	----

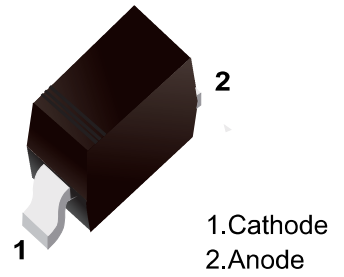

■ **Simplified outline(SOD-123)**

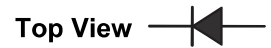

■ **Absolute Maximum Ratings Ta = 25°C**

Parameter	Symbol	Rating	Unit
Reverse Voltage	V _{RM}	300	V
Peak Repetitive Peak Reverse Voltage	V _{RRM}	300	
Working Peak Reverse Voltage	V _{RWM}		
DC Blocking Voltage	V _R		
RMS Reverse Voltage	V _{R(RMS)}	71	mA
Average Rectified Output Current	I _O	300	
Forward Continuous Current	I _{FM}	400	A
Peak Forward Surge Current @ t=1us	I _{FSM}	2	
@ t=1s		1	
Power Dissipation	P _d	500	mW
Thermal Resistance Junction to Ambient	R _{θJA}	250	°C/W
Junction Temperature	T _J	150	°C
Storage Temperature range	T _{stg}	-55 to 150	

■ **Electrical Characteristics Ta = 25°C**

Parameter	Symbol	Test Conditions	Min	Typ	Max	Unit
Reverse breakdown voltage	V _R	I _R = 100uA	100			V
Forward voltage	V _{F1}	I _F = 1mA			0.715	
	V _{F2}	I _F = 10 mA			0.855	
	V _{F3}	I _F = 50 mA			1	
	V _{F4}	I _F = 150 mA			1.25	
Reverse voltage leakage current	I _{R1}	V _R = 75 V			1	uA
	I _{R2}	V _R =20 V			25	nA
Junction capacitance	C _j	V _R = 0 V, f= 1 MHz			2	pF
Reverse recovery time	t _{rr}	I _F =I _R =10mA,I _{rr} =0.1xI _R , R _L =100Ω			4	ns

■ Typical Characteristics

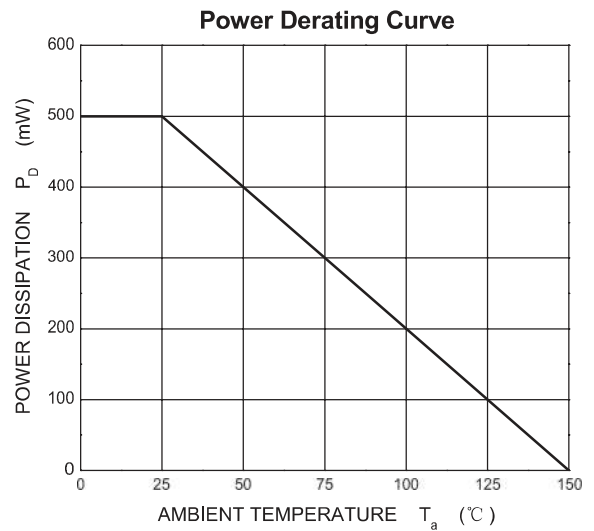
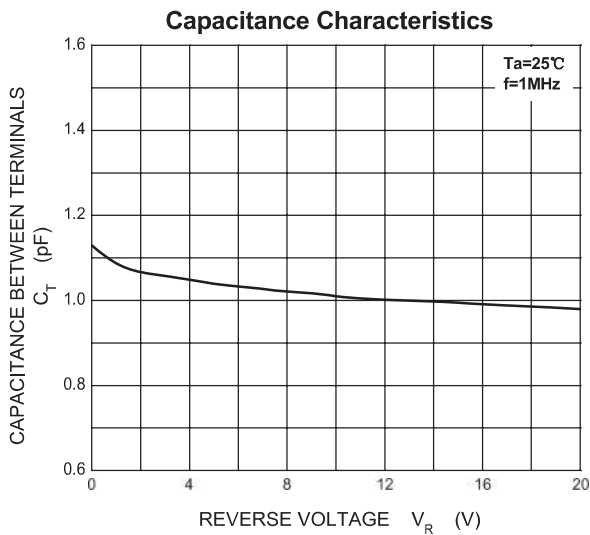
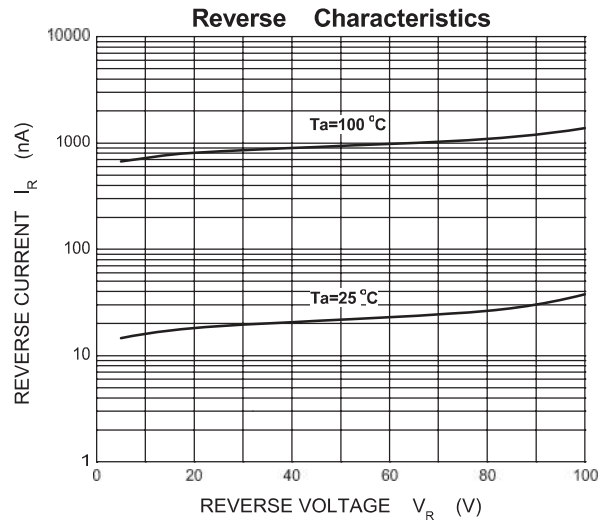
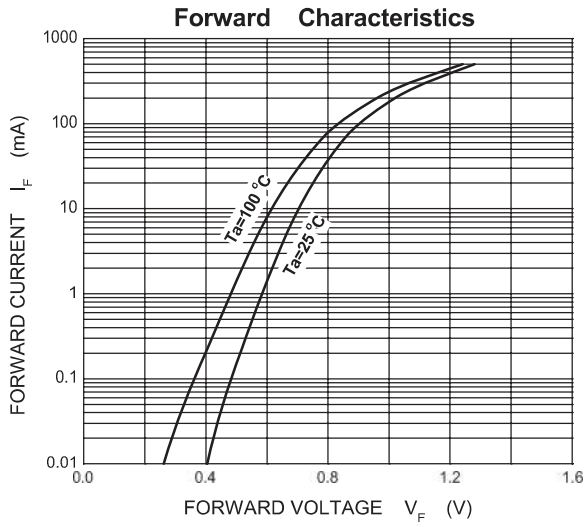

Package Outline SOD-123

Plastic surface mounted package; 2 leads

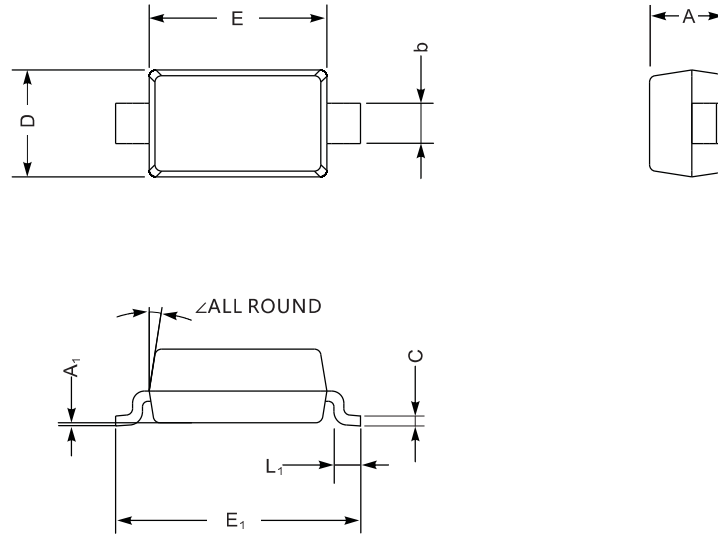

UNIT		A	C	D	E	E ₁	L ₁	b	A ₁	∠
mm	max	1.3	0.22	1.8	2.8	3.9	0.45	0.7	0.2	9°
	min	0.9	0.09	1.5	2.5	3.6	0.25	0.5	—	
mil	max	51	8.7	71	110	154	18	28	8	
	min	35	3.5	59	98	142	10	20	—	

The recommended mounting pad size

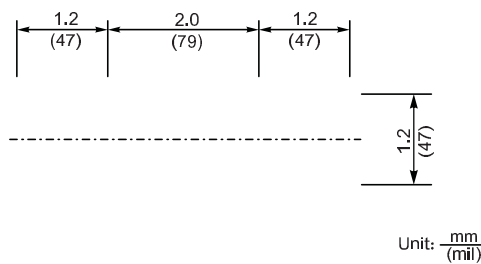

Summary of Packing Options

Package	Packing Description	Packing Quantity	Industry Standard
SOD-123	Tape/Reel, 7" reel	3000	EIA-481-1