

## Surface Mount General Purpose Silicon Rectifiers

**Reverse Voltage - 50 to 1000 V**

**Forward Current - 1 A**

### FEATURES

- ◆ For surface mounted applications
- ◆ Low profile package
- ◆ Glass Passivated Chip Junction
- ◆ Ideal for automated placement
- ◆ Lead free in comply with EU RoHS 2011/65/EU directives

### MECHANICAL DATA

- ◆ Case: SMAF
- ◆ Terminals: Solderable per MIL-STD-750, Method 2026
- ◆ Approx. Weight: 27mg / 0.00095oz

### Maximum Ratings and Electrical characteristics

Ratings at 25 °C ambient temperature unless otherwise specified.  
Single phase half-wave 60 Hz, resistive or inductive load, for capacitive load current derate by 20 %.

### Pinning

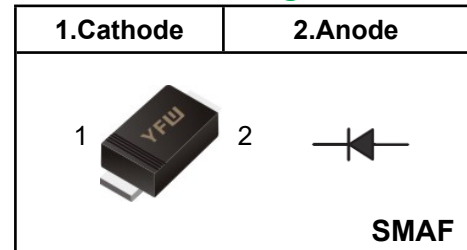

### Marking Code

<b>M1F</b>	<b>M1</b>
<b>M2F</b>	<b>M2</b>
<b>M3F</b>	<b>M3</b>
<b>M4F</b>	<b>M4</b>
<b>M5F</b>	<b>M5</b>
<b>M6F</b>	<b>M6</b>
<b>M7F</b>	<b>M7</b>

Parameter	Symbols	M1F	M2F	M3F	M4F	M5F	M6F	M7F	Units
Maximum Repetitive Peak Reverse Voltage	$V_{RRM}$	50	100	200	400	600	800	1000	V
Maximum RMS voltage	$V_{RMS}$	35	70	140	280	420	560	700	V
Maximum DC Blocking Voltage	$V_{DC}$	50	100	200	400	600	800	1000	V
Maximum Average Forward Rectified Current at $T_c = 125\text{ }^\circ\text{C}$	$I_{F(AV)}$	1							A
Peak Forward Surge Current 8.3 ms Single Half Sine Wave Superimposed on Rated Load	$I_{FSM}$	30							A
Maximum Instantaneous Forward Voltage at 1 A	$V_F$	1.1							V
Maximum DC Reverse Current $T_a = 25\text{ }^\circ\text{C}$ at Rated DC Blocking Voltage $T_a = 125\text{ }^\circ\text{C}$	$I_R$	5 50							$\mu\text{A}$
Typical Junction Capacitance <sup>(1)</sup>	$C_j$	15							pF
Typical Thermal Resistance <sup>(2)</sup>	$R_{\theta JA}$	80							$^\circ\text{C/W}$
Operating and Storage Temperature Range	$T_j, T_{stg}$	-55 ~ +150							$^\circ\text{C}$

(1) Measured at 1 MHz and applied reverse voltage of 4 V D.C

(2) P.C.B. mounted with 2.0" X 2.0" (5 X 5 cm) copper pad areas.

**Fig.1 Forward Current Derating Curve**

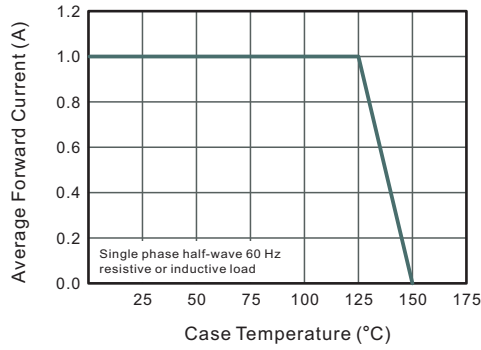

**Fig.2 Typical Instantaneous Reverse Characteristics**

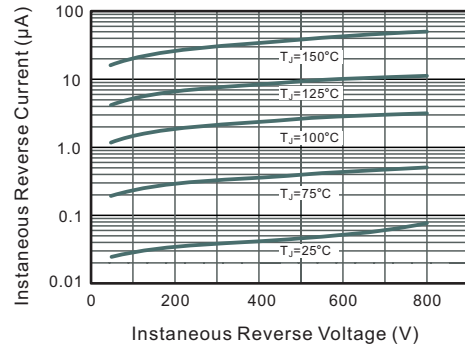

**Fig.3 Typical Forward Characteristic**

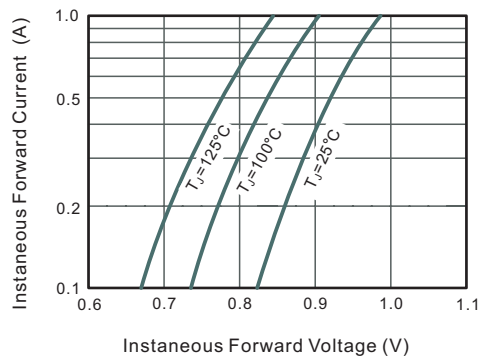

**Fig.4 Typical Junction Capacitance**

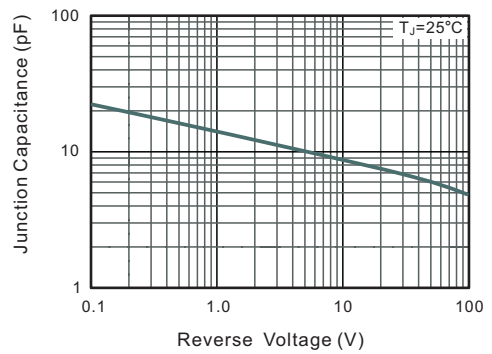

**Fig.5 Maximum Non-Repetitive Peak Forward Surge Current**

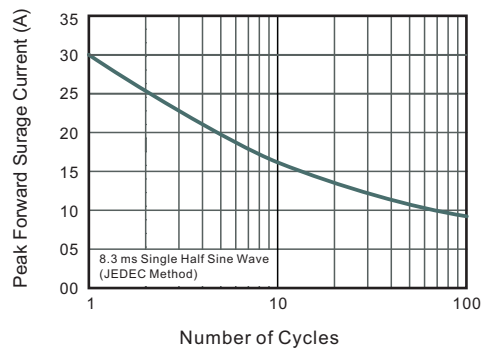

**Package Outline**

**SMAF**

Plastic surface mounted package; 2 leads

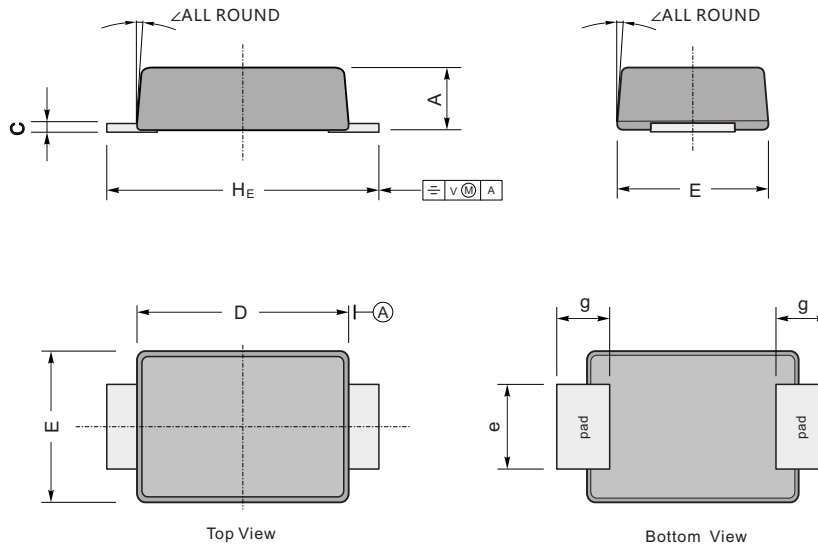

UNIT		A	C	D	E	e	g	H <sub>E</sub>	$\angle$
mm	max	1.1	0.20	3.7	2.7	1.6	1.2	4.9	7°
	min	0.9	0.12	3.3	2.4	1.3	0.8	4.4	
mil	max	43	7.9	146	106	63	47	193	
	min	35	4.7	130	94	51	31	173	

**The recommended mounting pad size**

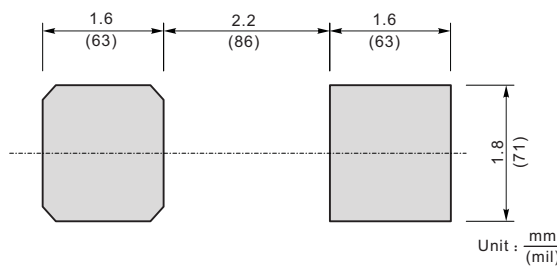

**Summary of Packing Options**

Package	Packing Description	Packing Quantity	Industry Standard
SMAF	Tape/Reel, 13" reel	10000	EIA-481-1
	Tape/Reel, 7" reel	3000	EIA-481-1