

## Surface Mount General Purpose Silicon Rectifiers

**Reverse Voltage - 50 to 1000 V**

**Forward Current - 3 A**

### FEATURES

- ◆ For surface mounted applications
- ◆ Low profile package
- ◆ Glass Passivated Chip Junction
- ◆ Ideal for automated placement
- ◆ Lead free in comply with EU RoHS 2011/65/EU directives

### MECHANICAL DATA

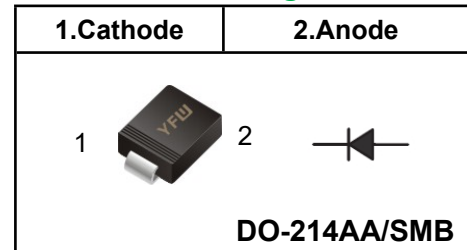
- ◆ Case: DO-214AA/SMB
- ◆ Terminals: Solderable per MIL-STD-750, Method 2026
- ◆ Approx. Weight: 0.093g / 0.003oz

### Maximum Ratings and Electrical characteristics

Ratings at 25 °C ambient temperature unless otherwise specified.

Single phase half-wave 60 Hz, resistive or inductive load, for capacitive load current derate by 20 %.

### Pinning



### Marking Code

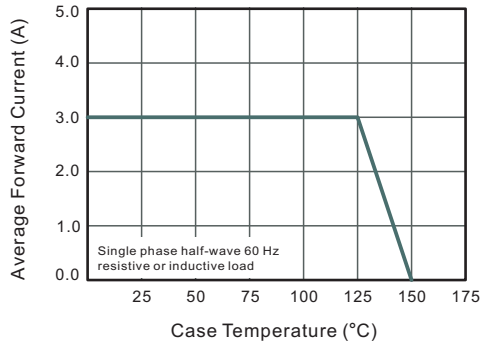
<b>S3AB</b>	<b>S3A</b>
<b>S3BB</b>	<b>S3B</b>
<b>S3DB</b>	<b>S3D</b>
<b>S3GB</b>	<b>S3G</b>
<b>S3JB</b>	<b>S3J</b>
<b>S3KB</b>	<b>S3K</b>
<b>S3MB</b>	<b>S3M</b>

Parameter	Symbols	S3AB	S3BB	S3DB	S3GB	S3JB	S3KB	S3MB	Units
Maximum Repetitive Peak Reverse Voltage	$V_{RRM}$	50	100	200	400	600	800	1000	V
Maximum RMS voltage	$V_{RMS}$	35	70	140	280	420	560	700	V
Maximum DC Blocking Voltage	$V_{DC}$	50	100	200	400	600	800	1000	V
Maximum Average Forward Rectified Current at $T_c = 125\text{ }^\circ\text{C}$	$I_{F(AV)}$	3							A
Peak Forward Surge Current 8.3 ms Single Half Sine Wave Superimposed on Rated Load	$I_{FSM}$	90							A
Maximum Instantaneous Forward Voltage at 3 A	$V_F$	1.1							V
Maximum DC Reverse Current $T_a = 25\text{ }^\circ\text{C}$ at Rated DC Blocking Voltage $T_a = 125\text{ }^\circ\text{C}$	$I_R$	5 50							$\mu\text{A}$
Typical Junction Capacitance <sup>(1)</sup>	$C_j$	35							pF
Typical Thermal Resistance <sup>(2)</sup>	$R_{\theta JA}, R_{\theta JC}$	48/16							$^\circ\text{C/W}$
Operating and Storage Temperature Range	$T_j, T_{stg}$	-55 ~ +150							$^\circ\text{C}$

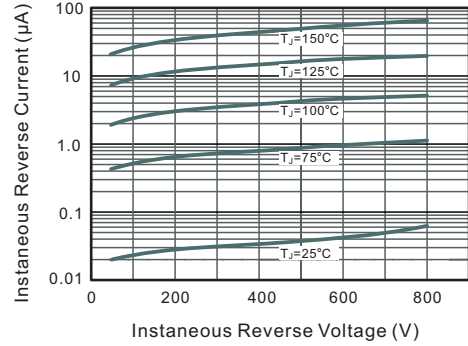
(1) Measured at 1 MHz and applied reverse voltage of 4 V D.C

(2) P.C.B. mounted with 2.0" X 2.0" (5 X 5 cm) copper pad areas.

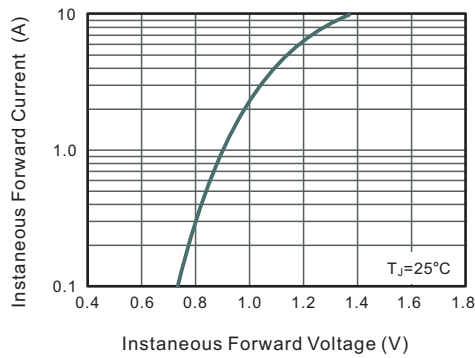
**Fig.1 Forward Current Derating Curve**



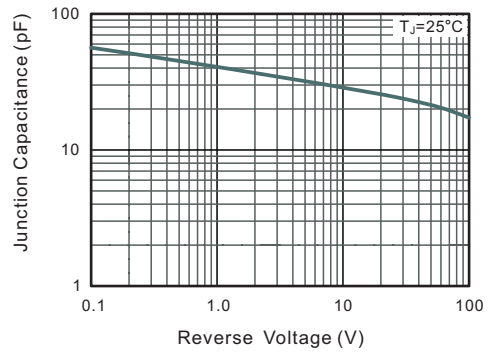
**Fig.2 Typical Instaneous Reverse Characteristics**



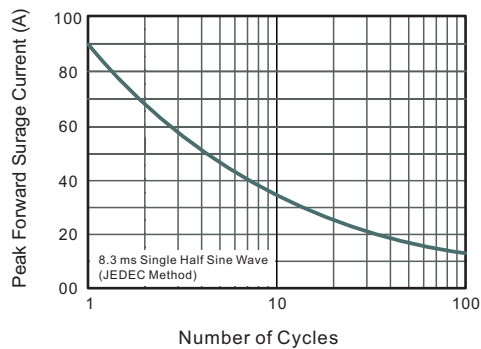
**Fig.3 Typical Forward Characteristic**



**Fig.4 Typical Junction Capacitance**

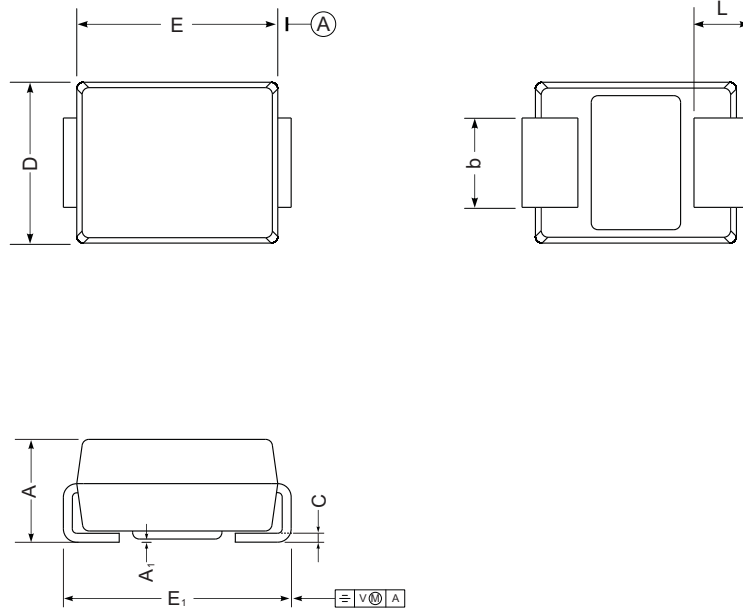


**Fig.5 Maximum Non-Repetitive Peak Forward Surge Current**



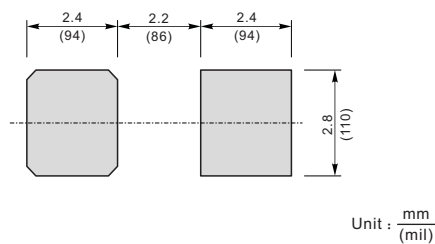
**Package Outline DO-214AA SMB**

Plastic surface mounted package; 2 leads



UNIT		A	E	D	E <sub>1</sub>	A <sub>1</sub>	L	C	b
mm	max	2.44	4.70	3.94	5.59	0.20	1.5	0.305	2.2
	min	2.13	4.06	3.3	5.08	0.05	0.8	0.152	1.9
mil	max	96	185	155	220	7.9	59	12	87
	min	84	160	130	200	2.0	32	6	75

**The recommended mounting pad size**



**Summary of Packing Options**

Package	Packing Description	Packing Quantity	Industry Standard
DO-214AA SMB	Tape/Reel, 13" reel	3000	EIA-481-1