

25A GLASS PASSIVATED BRIDGE RECTIFIER Reverse

Voltage - 100 to 1000 V

Forward Current – 25A

FEATURES

- ◆ Surge overload rating-350 amperes peak
- ◆ Polarity:As marked on body
- ◆ Ideal for printed circuit board
- ◆ Plastic material has U/L
The flammability classification 94V-0
- ◆ Reliable low cost construction utilizing molded plastic technique

MECHANICAL DATA

- ◆ Case: GBU
- ◆ Terminals: Solderable per MIL-STD-202, Method 208
- ◆ Approx. Weight: 3.9g /0.138oz

Maximum Ratings and Electrical characteristics

Ratings at 25 °C ambient temperature unless otherwise specified.

Single phase half-wave 60 Hz, resistive or inductive load, for capacitive load current derate by 20 %.

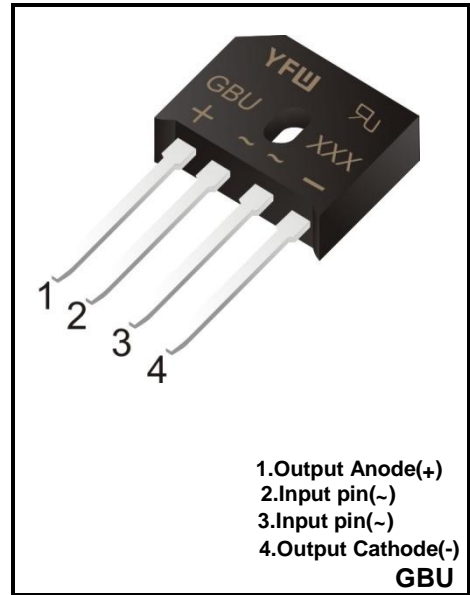

Parameter	Symbols	GBU2501	GBU2502	GBU2504	GBU2506	GBU2508	GBU2510	Units
Maximum Repetitive Peak Reverse Voltage	V_{RRM}	100	200	400	600	800	1000	V
Maximum RMS voltage	V_{RMS}	70	140	280	420	560	700	V
Maximum DC Blocking Voltage	V_{DC}	100	200	400	600	800	1000	V
Maximum Average Forward Rectified Current at $T_c=100^{\circ}C$ (Note 1)	$I_{(AV)}$	25.0 4.2						A
Peak Forward Surge Current 8.3 ms Single Half Sine-Wave Superimposed on Rated Load (JEDEC method)	I_{FSM}	350						A
Forward Voltage per element @ $I_F=12.5A$ DC	V_F	1.0						V
Maximum DC Reverse Current at Rated DC Blocking Voltage @ $T_a=25^{\circ}C$ @ $T_a=125^{\circ}C$	I_R	10 500						μA
I ² t Rating for Fusing(3ms≤t≤8.3ms)	I^2t	508						A ² S
Typical Junction Capacitance (Note1)	C_j	70						pF
Typical Thermal Resistance (Note2)	$R_{\theta JC}$	2.2						°C/W
Operating and Storage Temperature Range	T_j, T_{stg}	-55 ~ +150						°C

(1) Measured at 1 MHz and applied reverse voltage of 4 V D.C

(2) Device mounted on 150mm*150mm*16mm cu plate heatsink

Ratings And Characteristic Curves

FIG.1-MAXIMUM FORWARD SURGE CURRENT

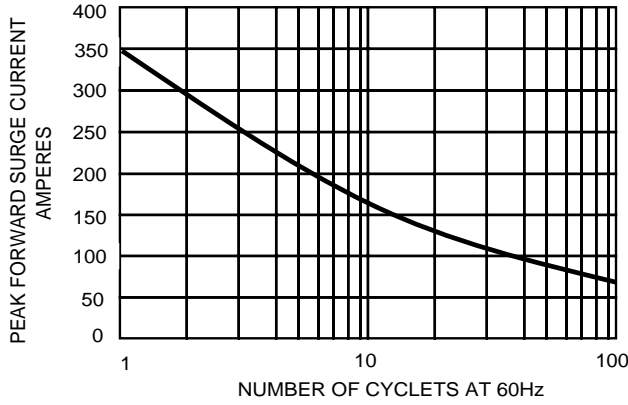

FIG.2- DERATING CURVE
OUTPUT RECTIFIED CURRENT

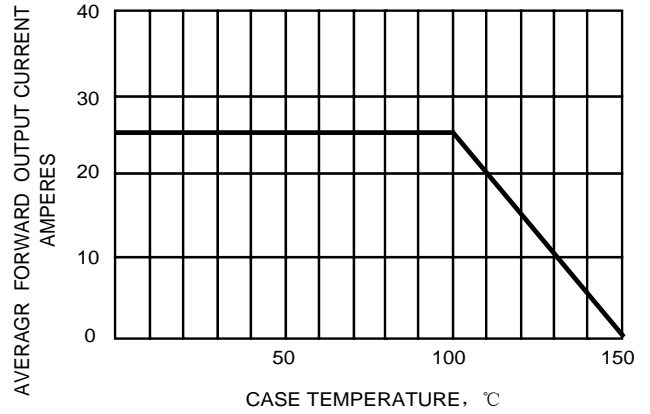

FIG.3-TYPICAL FORWARD CHARACTERISTICS

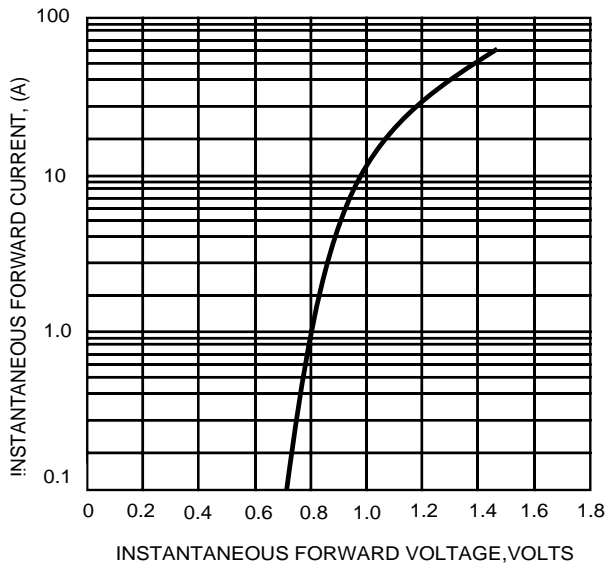
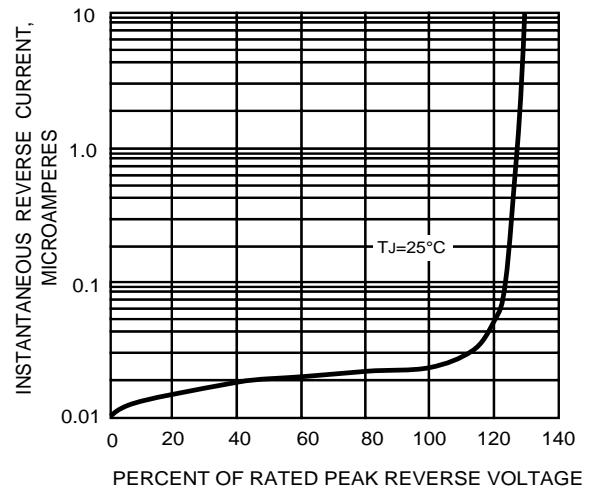
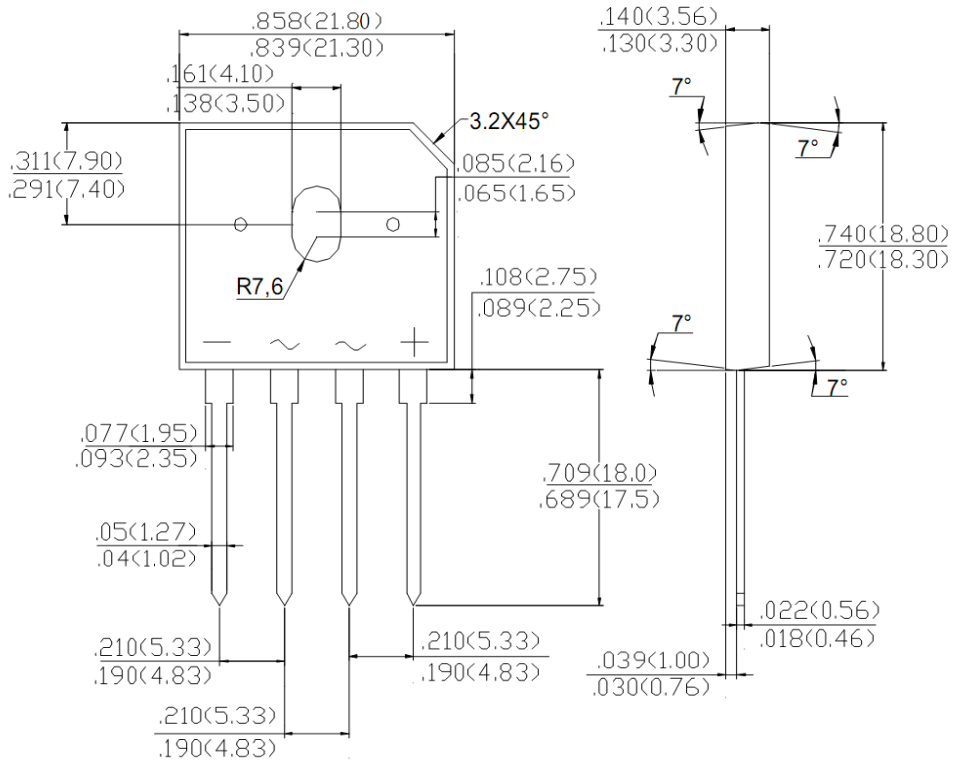

FIG.4-TYPICAL REVERSE CHARACTERISTICS



Package Outline

GBU



Summary of Packing Options

Package	Packing Description	Packing Quantity	Industry Standard
GBU	BOX	500	EIA-481-1