

6.0A GLASS PASSIVATED BRIDGE RECTIFIER

Reverse Voltage - 100 to 1000 V

Forward Current – 6.0A

FEATURES

- ◆ Surge overload rating-150 amperes peak
- ◆ Polarity:As marked on body
- ◆ Ideal for printed circuit board
- ◆ Plastic material has U/L

The flammability classification 94V-0

- ◆ Reliable low cost construction utilizing molded plastic technique

MECHANICAL DATA

- ◆ Case: KBL
- ◆ Terminals: Solderable per MIL-STD-202, Method 208
- ◆ Approx. Weight: 5.6g /0.2oz

Maximum Ratings and Electrical characteristics

Ratings at 25 °C ambient temperature unless otherwise specified.

Single phase half-wave 60 Hz, resistive or inductive load, for capacitive load current derate by 20 %.

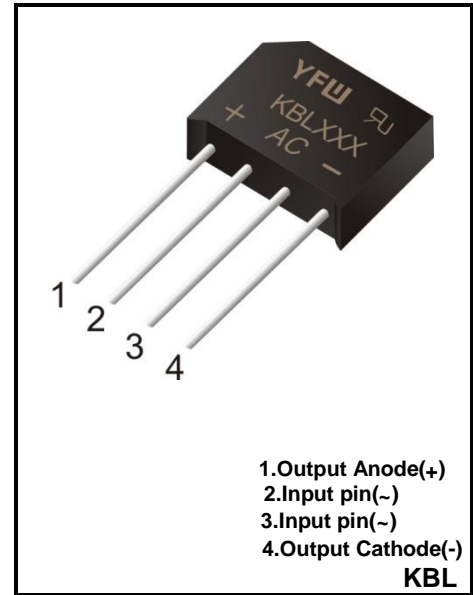

Parameter	Symbols	KBL601	KBL602	KBL604	KBL606	KBL608	KBL610	Units	
Maximum Repetitive Peak Reverse Voltage	V_{RRM}	100	200	400	600	800	1000	V	
Maximum RMS voltage	V_{RMS}	70	140	280	420	560	700	V	
Maximum DC Blocking Voltage	V_{DC}	100	200	400	600	800	1000	V	
Maximum Average Forward Rectified Current at $T_C=100^{\circ}C$ (Note 1)	$I_{(AV)}$					6.0 3.5			A
Peak Forward Surge Current 8.3 ms Single Half Sine-Wave Superimposed on Rated Load (JEDEC method)	I_{FSM}					150			A
Forward Voltage per element at 3.0A DC and 25°C	V_F					1.0			V
Maximum DC Reverse Current at Rated DC Blocking Voltage @Ta=25°C @Ta=125°C	I_R					10 500			μA
I2t Rating for Fusing(3ms≤t≤8.3ms)	I^2t					175			A ² S
Typical Junction Capacitance (Note1)	C_J					105			pF
Typical Thermal Resistance (Note2)	$R_{\theta JA}$					20			°C/W
Operating and Storage Temperature Range	T_j, T_{stg}					-55 ~ +150		°C	

(1) Measured at 1 MHz and applied reverse voltage of 4 V D.C

(2) Unit case mounted on 7.5" x 7.5" x 0.3cm" Al plate heat sink.

AVERAGE FORWARD RECTIFIED CURRENT,
AMPERES

FIG. 1- FORWARD CURRENT DERATING CURVE

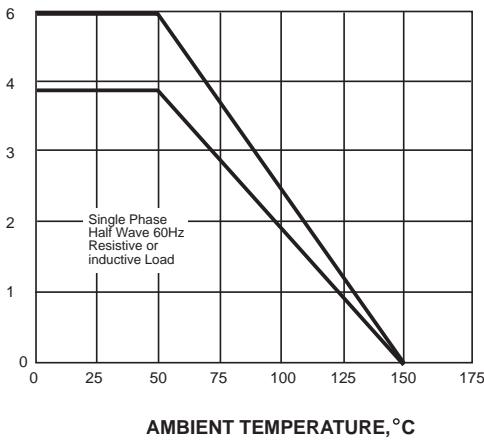

PEAK FORWARD SURGE CURRENT,
AMPERES

FIG. 2-MAXIMUM NON-REPETITIVE PEAK FORWARD SURGE CURRENT

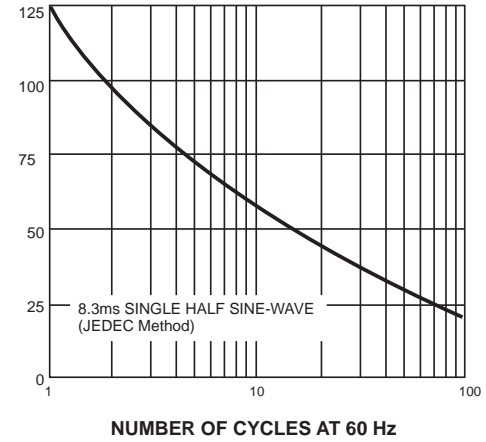
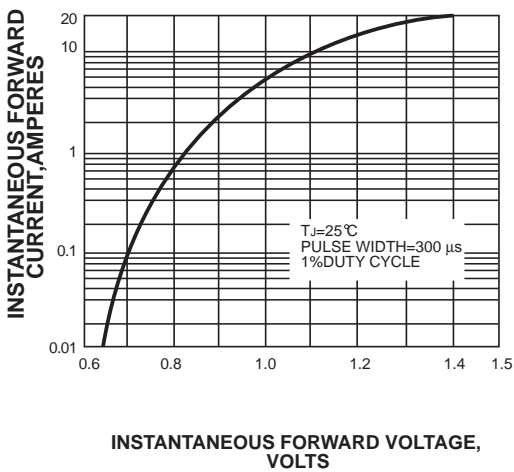

FIG. 3-TYPICAL INSTANTANEOUS FORWARD CHARACTERISTICS



INSTANTANEOUS REVERSE CURRENT,
MICROAMPERES

FIG. 4-TYPICAL REVERSE CHARACTERISTICS

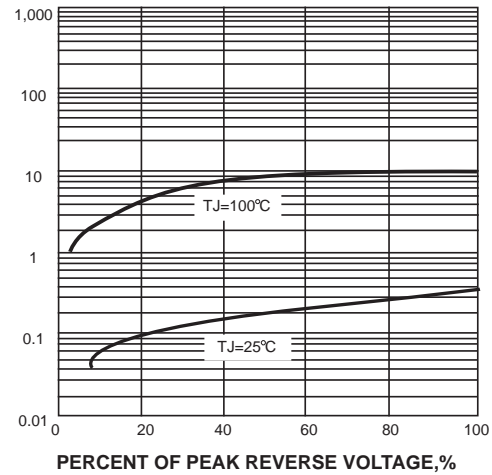
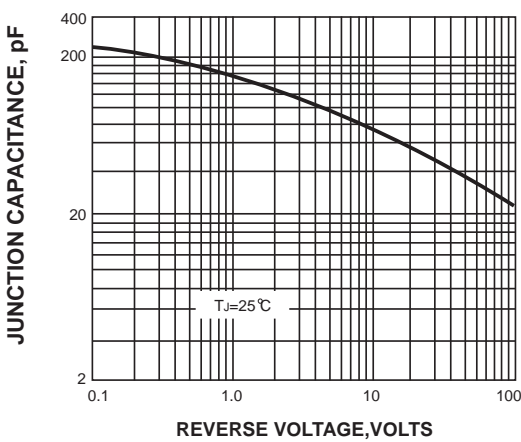
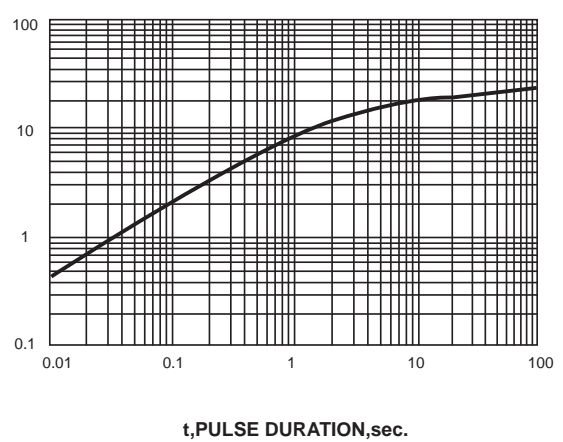

FIG. 5-TYPICAL JUNCTION CAPACITANCE



TRANSIENT THERMAL IMPEDANCE,
°C/W

FIG. 6-TYPICAL TRANSIENT THERMAL IMPEDANCE



Package Outline

KBL

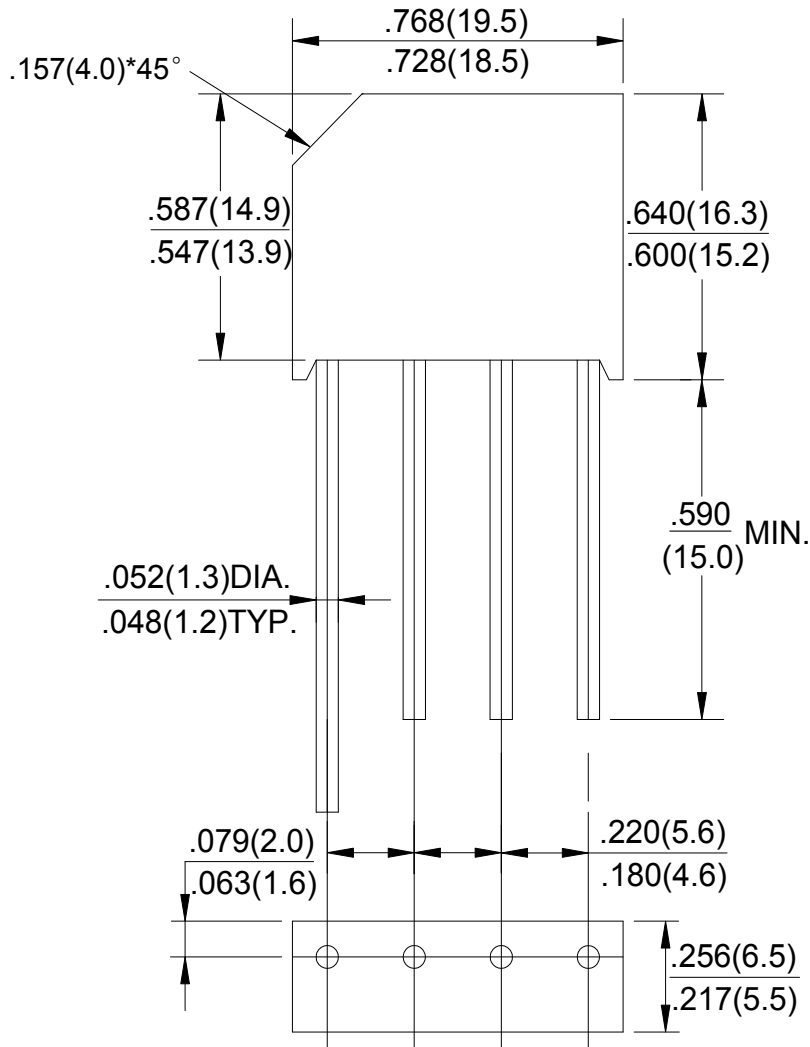

Dimensions in inches and (millimeters)

Summary of Packing Options

Package	Packing Description	Packing Quantity	Industry Standard
KBL	BOX	500	EIA-481-1