

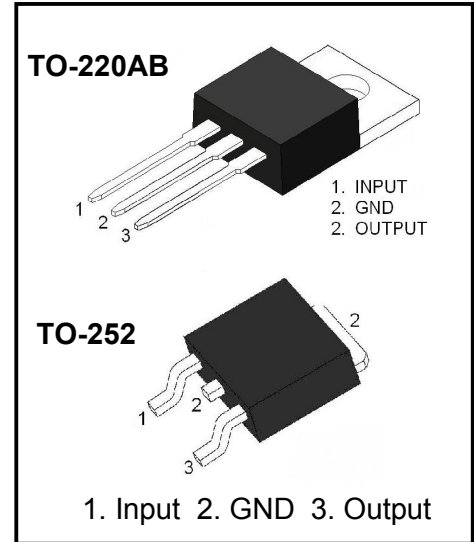
**3-Terminal 0.5A Positive Voltage Regulator**

**Description**

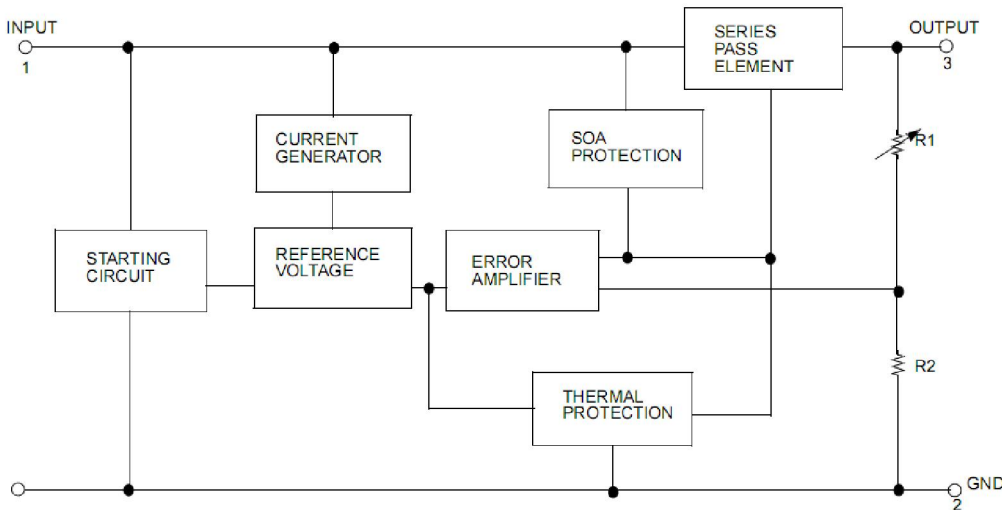
The 78MXX series of three-terminal positive regulators are available in the TO-220AB /TO-252 package with several fixed output voltages making it useful in a wide range of applications.

**Features**

- ◆ Output Current up to 0.5A
- ◆ Output Voltages of 5,6,8,10,12,15,18,20,24V
- ◆ Thermal Overload Protection
- ◆ Short Circuit Protection
- ◆ Output Transistor Safe Operating area (SOA)Protection



**Internal Block Diagram**



**Absolute Maximum Ratings**

| Parameter                                    |                     | Symbol          | Value           | Unit          |
|--|---------------------|-----------------|-----------------|---------------|
| Input Voltage                                | $V_O = 5V \sim 18V$ | $V_{IN}$        | 35              | V             |
|  | $V_O = 24V$         |                 | 40              |               |
| Thermal Resistance Junction-Cases (TO-220AB) |                     | $R_{\theta JC}$ | 5               | $^{\circ}C/W$ |
| Thermal Resistance Junction-Air              | TO-220AB            | $R_{\theta JA}$ | 65              | $^{\circ}C/W$ |
|  | TO-252              |                 | 92              |               |
| Operating Temperature Range                  |                     | $T_{OPR}$       | $0 \sim +125$   | $^{\circ}C$   |
| Storage Temperature Range                    |                     | $T_{STG}$       | $-55 \sim +150$ | $^{\circ}C$   |

**Note1** .Absolute maximum ratings are those values beyond which damage to the device may occur. The datasheet specifications should be met, without exception, to ensure that the system design is reliable over its power supply, temperature, and output/input loading variables. Fairchild does not recommend operation outside datasheet specifications.

**Electrical Characteristics (78M05D)**

( $V_I = 10V$ ,  $I_O = 0.5A$ ,  $C_I = 0.33\mu F$ ,  $C_O = 0.1\mu F$ ,  $T_J = -40^\circ C$  to  $125^\circ C$ , unless otherwise specified)

| Parameter                | Symbol                | Conditions                                | Min                      | Typ  | Max  | Unit        |
|--------------------------|-----------------------|---|--------------------------|------|------|-------------|
| Output Voltage           | $V_O$                 | $T_J = 25^\circ C$ , $I_O = 5mA \sim 1A$  | 4.80                     | 5.0  | 5.20 | V           |
|                          |                       | $V_I = 7V \sim 20V$ , $I_O = 5mA \sim 1A$ | 4.75                     | 5.0  | 5.25 | V           |
| Line Regulation ②        | $\Delta V_O$          | $T_J = 25^\circ C$                        | $V_I = 7V \sim 25V$      |      | 100  | mV          |
|                          |                       |   | $V_I = 8V \sim 12V$      |      | 50   |             |
| Load Regulation ②        | $\Delta V_O$          | $T_J = 25^\circ C$                        | $I_O = 5mA \sim 1A$      |      | 100  | mV          |
|                          |                       |   | $I_O = 0.25A \sim 0.75A$ |      | 50   |             |
| Quiescent Current        | $I_Q$                 | $T_J = 25^\circ C$                        |                          |      | 8.0  | mA          |
| Quiescent Current Change | $\Delta I_Q$          | $I_O = 5mA \sim 1A$                       |                          |      | 0.5  | mA          |
|                          |                       | $V_I = 7V \sim 25V$                       |                          |      | 1.3  |             |
| Output Voltage Drift ③   | $\Delta V / \Delta T$ | $I_O = 5mA$                               |                          | -0.8 |      | mV/°C       |
| Output Noise Voltage     | $V_N$                 | $10Hz \leq f \leq 100KHz$                 |                          | 42   |      | $\mu V/V_O$ |
| Ripple Rejection ③       | RR                    | $f = 120Hz$ , $V_I = 8V \sim 18V$         | 62                       | 73   |      | dB          |
| Output Resistance ③      | $R_O$                 | $f = 1kHz$                                |                          | 15   |      | m $\Omega$  |
| Short Circuit Current    | $I_{SC}$              | $T_J = 25^\circ C$ , $V_I = 30V$          |                          | 230  |      | mA          |
| Peak Out Current ③       | $I_{PK}$              | $T_J = 25^\circ C$                        |                          | 1.8  |      | A           |
| Dropout Voltage          | $V_d$                 | $T_J = 25^\circ C$ , $I_O = 0.5A$         |                          | 2.0  |      | V           |

**Note 2:** Load and line regulation are specified at constant junction temperature. Changes in  $V_O$  due to heating effects must be taken into account separately. Pulse testing with low duty is used.

**Note 3:** These parameters, although guaranteed, are not 100% tested in production.

**Electrical Characteristics (78M06D)**

( $V_I = 11V$ ,  $I_O = 0.5A$ ,  $C_I = 0.33\mu F$ ,  $C_O = 0.1\mu F$ ,  $T_j = -40$  to  $125^\circ C$ , unless otherwise specified)

| Parameter                | Symbol                | Conditions                                | Min                      | Typ  | Max  | Unit           |
|--------------------------|-----------------------|---|--------------------------|------|------|----------------|
| Output Voltage           | $V_O$                 | $T_j = 25^\circ C$ , $I_O = 5mA \sim 1A$  | 5.76                     | 6.0  | 6.24 | V              |
|                          |                       | $V_I = 8V \sim 12V$ , $I_O = 5mA \sim 1A$ | 5.70                     | 6.0  | 6.30 | V              |
| Line Regulation ④        | $\Delta V_O$          | $T_j = 25^\circ C$                        | $V_I = 8V \sim 25V$      |      | 120  | mV             |
|                          |                       |   | $V_I = 9V \sim 13V$      |      | 60   |                |
| Load Regulation ④        | $\Delta V_O$          | $T_j = 25^\circ C$                        | $I_O = 5mA \sim 1A$      |      | 120  | mV             |
|                          |                       |   | $I_O = 0.25A \sim 0.75A$ |      | 60   |                |
| Quiescent Current        | $I_Q$                 | $T_j = 25^\circ C$                        |                          |      | 8.0  | mA             |
| Quiescent Current Change | $\Delta I_Q$          | $I_O = 5mA \sim 1A$                       |                          |      | 0.5  | mA             |
|                          |                       | $V_I = 8V \sim 25V$                       |                          |      | 1.3  |                |
| Output Voltage Drift ⑤   | $\Delta V / \Delta T$ | $I_O = 5mA$                               |                          | -0.8 |      | mV/ $^\circ C$ |
| Output Noise Voltage     | $V_N$                 | $10Hz \leq f \leq 100KHz$                 |                          | 76   |      | $\mu V/V_O$    |
| Ripple Rejection ⑤       | RR                    | $f = 120Hz, V_I = 8V \sim 18V$            | 55                       | 71   |      | dB             |
| Output Resistance ⑤      | $R_O$                 | $f = 1kHz$                                |                          | 19   |      | m $\Omega$     |
| Short Circuit Current    | $I_{SC}$              | $T_j = 25^\circ C$ , $V_I = 30V$          |                          | 230  |      | mA             |
| Peak Out Current ⑤       | $I_{PK}$              | $T_j = 25^\circ C$                        |                          | 1.8  |      | A              |
| Dropout Voltage          | $V_d$                 | $T_j = 25^\circ C$ , $I_O = 0.5A$         |                          | 2.0  |      | V              |

**Note 4:** Load and line regulation are specified at constant junction temperature. Changes in  $V_O$  due to heating effects must be taken into account separately. Pulse testing with low duty is used.

**Note 5:** These parameters, although guaranteed, are not 100% tested in production.

**Electrical Characteristics (78M08D)**

( $V_I = 14V$ ,  $I_O = 0.5A$ ,  $C_I = 0.33\mu F$ ,  $C_O = 0.1\mu F$ ,  $T_j = -40$  to  $125^\circ C$ , unless otherwise specified)

| Parameter                | Symbol                | Conditions                                   | Min                      | Typ  | Max  | Unit           |
|--------------------------|-----------------------|--|--------------------------|------|------|----------------|
| Output Voltage           | $V_O$                 | $T_j = 25^\circ C$ , $I_O = 5mA \sim 1A$     | 7.68                     | 8.0  | 8.32 | V              |
|                          |                       | $V_I = 10.5V \sim 23V$ , $I_O = 5mA \sim 1A$ | 7.60                     | 8.0  | 8.40 | V              |
| Line Regulation ⑥        | $\Delta V_O$          | $T_j = 25^\circ C$                           | $V_I = 10.5V \sim 25V$   |      | 160  | mV             |
|                          |                       |  | $V_I = 11.5V \sim 17V$   |      | 80   |                |
| Load Regulation ⑥        | $\Delta V_O$          | $T_j = 25^\circ C$                           | $I_O = 5mA \sim 1A$      |      | 160  | mV             |
|                          |                       |  | $I_O = 0.25A \sim 0.75A$ |      | 80   |                |
| Quiescent Current        | $I_Q$                 | $T_j = 25^\circ C$                           |                          |      | 8.0  | mA             |
| Quiescent Current Change | $\Delta I_Q$          | $I_O = 5mA \sim 1A$                          |                          |      | 0.5  | mA             |
|                          |                       | $V_I = 10.5V \sim 25V$                       |                          |      | 1.0  |                |
| Output Voltage Drift ⑦   | $\Delta V / \Delta T$ | $I_O = 5mA$                                  |                          | -0.8 |      | mV/ $^\circ C$ |
| Output Noise Voltage     | $V_N$                 | $10Hz \leq f \leq 100KHz$                    |                          | 52   |      | $\mu V/V_O$    |
| Ripple Rejection ⑦       | RR                    | $f = 120Hz$ , $V_I = 11.5V \sim 21.5V$       | 56                       | 73   |      | dB             |
| Output Resistance ⑦      | $R_O$                 | $f = 1kHz$                                   |                          | 17   |      | m $\Omega$     |
| Short Circuit Current    | $I_{SC}$              | $T_j = 25^\circ C$ , $V_I = 30V$             |                          | 230  |      | mA             |
| Peak Out Current ⑦       | $I_{PK}$              | $T_j = 25^\circ C$                           |                          | 1.8  |      | A              |
| Dropout Voltage          | $V_d$                 | $T_j = 25^\circ C$ , $I_O = 0.5A$            |                          | 2.0  |      | V              |

**Note 6:** Load and line regulation are specified at constant junction temperature. Changes in  $V_O$  due to heating effects must be taken into account separately. Pulse testing with low duty is used.

**Note 7:** These parameters, although guaranteed, are not 100% tested in production.

**Electrical Characteristics (78M09D)**

( $V_I = 15V$ ,  $I_O = 0.5A$ ,  $C_I = 0.33\mu F$ ,  $C_O = 0.1\mu F$ ,  $T_j = -40$  to  $125^\circ C$ , unless otherwise specified)

| Parameter                | Symbol                | Conditions                                   | Min                      | Typ  | Max  | Unit           |
|--------------------------|-----------------------|--|--------------------------|------|------|----------------|
| Output Voltage           | $V_O$                 | $T_j = 25^\circ C$ , $I_O = 5mA \sim 1A$     | 8.64                     | 9.0  | 9.36 | V              |
|                          |                       | $V_I = 11.5V \sim 24V$ , $I_O = 5mA \sim 1A$ | 8.55                     | 9.0  | 9.45 | V              |
| Line Regulation ⑧        | $\Delta V_O$          | $T_j = 25^\circ C$                           | $V_I = 11.5V \sim 25V$   |      | 180  | mV             |
|                          |                       |  | $V_I = 12V \sim 17V$     |      | 90   |                |
| Load Regulation ⑧        | $\Delta V_O$          | $T_j = 25^\circ C$                           | $I_O = 5mA \sim 1A$      |      | 180  | mV             |
|                          |                       |  | $I_O = 0.25A \sim 0.75A$ |      | 90   |                |
| Quiescent Current        | $I_Q$                 | $T_j = 25^\circ C$                           |                          |      | 8.0  | mA             |
| Quiescent Current Change | $\Delta I_Q$          | $I_O = 5mA \sim 1A$                          |                          |      | 0.5  | mA             |
|                          |                       | $V_I = 11.5V \sim 26V$                       |                          |      | 1.3  |                |
| Output Voltage Drift ⑨   | $\Delta V / \Delta T$ | $I_O = 5mA$                                  |                          | -1.0 |      | mV/ $^\circ C$ |
| Output Noise Voltage     | $V_N$                 | $10Hz \leq f \leq 100KHz$                    |                          | 52   |      | $\mu V/V_O$    |
| Ripple Rejection ⑨       | RR                    | $f = 120Hz$ , $V_I = 13V \sim 23V$           | 56                       | 71   |      | dB             |
| Short Circuit Current    | $I_{SC}$              | $T_j = 25^\circ C$ , $V_I = 30V$             |                          | 230  |      | mA             |
| Output Resistance ⑨      | $R_O$                 | $f = 1kHz$                                   |                          | 17   |      | m $\Omega$     |
| Peak Out Current ⑨       | $I_{PK}$              | $T_j = 25^\circ C$                           |                          | 1.8  |      | A              |
| Dropout Voltage          | $V_d$                 | $T_j = 25^\circ C$ , $I_O = 0.5A$            |                          | 2.0  |      | V              |

**Note 8:** Load and line regulation are specified at constant junction temperature. Changes in  $V_O$  due to heating effects must be taken into account separately. Pulse testing with low duty is used.

**Note 9:** These parameters, although guaranteed, are not 100% tested in production.

**Electrical Characteristics (78M10D)**

( $V_I = 16V$ ,  $I_O = 0.5A$ ,  $C_I = 0.33\mu F$ ,  $C_O = 0.1\mu F$ ,  $T_j = -40$  to  $125^\circ C$ , unless otherwise specified)

| Parameter                | Symbol                | Conditions                                   | Min                      | Typ  | Max   | Unit           |
|--------------------------|-----------------------|--|--------------------------|------|-------|----------------|
| Output Voltage           | $V_O$                 | $T_j = 25^\circ C$ , $I_O = 5mA \sim 1A$     | 9.60                     | 10.0 | 10.40 | V              |
|                          |                       | $V_I = 12.5V \sim 25V$ , $I_O = 5mA \sim 1A$ | 9.50                     | 10.0 | 10.50 | V              |
| Line Regulation ⑩        | $\Delta V_O$          | $T_j = 25^\circ C$                           | $V_I = 12.5V \sim 25V$   |      | 200   | mV             |
|                          |                       |  | $V_I = 13V \sim 25V$     |      | 100   |                |
| Load Regulation ⑩        | $\Delta V_O$          | $T_j = 25^\circ C$                           | $I_O = 5mA \sim 1A$      |      | 200   | mV             |
|                          |                       |  | $I_O = 0.25A \sim 0.75A$ |      | 100   |                |
| Quiescent Current        | $I_Q$                 | $T_j = 25^\circ C$                           |                          |      | 8.0   | mA             |
| Quiescent Current Change | $\Delta I_Q$          | $I_O = 5mA \sim 1A$                          |                          |      | 0.5   | mA             |
|                          |                       | $V_I = 12.5V \sim 29V$                       |                          |      | 1.0   |                |
| Output Voltage Drift ⑪   | $\Delta V / \Delta T$ | $I_O = 5mA$                                  |                          | -1.0 |       | mV/ $^\circ C$ |
| Output Noise Voltage     | $V_N$                 | $10Hz \leq f \leq 100KHz$                    |                          | 58   |       | $\mu V/V_O$    |
| Ripple Rejection ⑫       | RR                    | $f = 120Hz$ , $V_I = 13V \sim 23V$           | 56                       | 71   |       | dB             |
| Short Circuit Current    | $I_{SC}$              | $T_j = 25^\circ C$ , $V_I = 30V$             |                          | 230  |       | mA             |
| Output Resistance ⑬      | $R_O$                 | $f = 1kHz$                                   |                          | 17   |       | m $\Omega$     |
| Peak Out Current ⑭       | $I_{PK}$              | $T_j = 25^\circ C$                           |                          | 1.8  |       | A              |
| Dropout Voltage          | $V_d$                 | $T_j = 25^\circ C$ , $I_O = 0.5A$            |                          | 2.0  |       | V              |

**Note 10:** Load and line regulation are specified at constant junction temperature. Changes in  $V_O$  due to heating effects must be taken into account separately. Pulse testing with low duty is used.

**Note 11:** These parameters, although guaranteed, are not 100% tested in production.

**Electrical Characteristics (78M12D)**

( $V_I = 19V$ ,  $I_O = 0.5A$ ,  $C_I = 0.33\mu F$ ,  $C_O = 0.1\mu F$ ,  $T_j = -40$  to  $125^\circ C$ , unless otherwise specified)

| Parameter                | Symbol                | Conditions                                   | Min                      | Typ  | Max   | Unit           |
|--------------------------|-----------------------|--|--------------------------|------|-------|----------------|
| Output Voltage           | $V_O$                 | $T_j = 25^\circ C$ , $I_O = 5mA \sim 1A$     | 11.52                    | 12.0 | 12.48 | V              |
|                          |                       | $V_I = 14.5V \sim 27V$ , $I_O = 5mA \sim 1A$ | 11.40                    | 12.0 | 12.60 | V              |
| Line Regulation ⑫        | $\Delta V_O$          | $T_j = 25^\circ C$<br>$I_O = 0.5A$           | $V_I = 14.5V \sim 30V$   |      | 240   | mV             |
|                          |                       |  | $V_I = 11.5V \sim 24V$   |      | 120   |                |
| Load Regulation ⑫        | $\Delta V_O$          | $T_j = 25^\circ C$ ,                         | $I_O = 5mA \sim 1A$      |      | 240   | mV             |
|                          |                       |  | $I_O = 0.25A \sim 0.75A$ |      | 120   |                |
| Quiescent Current        | $I_Q$                 | $T_j = 25^\circ C$                           |                          |      | 8.0   | mA             |
| Quiescent Current Change | $\Delta I_Q$          | $I_O = 5mA \sim 1A$                          |                          |      | 0.5   | mA             |
|                          |                       | $V_I = 14.5V \sim 30V$                       |                          |      | 1.0   |                |
| Output Voltage Drift ⑬   | $\Delta V / \Delta T$ | $I_O = 5mA$                                  |                          | -1.0 |       | mV/ $^\circ C$ |
| Output Noise Voltage     | $V_N$                 | $10Hz \leq f \leq 100KHz$                    |                          | 76   |       | $\mu V / V_O$  |
| Ripple Rejection ⑬       | RR                    | $f = 120Hz$ , $V_I = 15V \sim 25V$           | 55                       | 71   |       | dB             |
| Output Resistance ⑬      | $R_O$                 | $f = 1kHz$                                   |                          | 18   |       | m $\Omega$     |
| Short Circuit Current    | $I_{SC}$              | $T_j = 25^\circ C$ , $V_I = 30V$             |                          | 230  |       | mA             |
| Peak Out Current ⑬       | $I_{PK}$              | $T_j = 25^\circ C$                           |                          | 1.8  |       | A              |
| Dropout Voltage          | $V_d$                 | $T_j = 25^\circ C$ , $I_O = 0.5A$            |                          | 2.0  |       | V              |

**Note 12:** Load and line regulation are specified at constant junction temperature. Changes in  $V_O$  due to heating effects must be taken into account separately. Pulse testing with low duty is used.

**Note 13:** These parameters, although guaranteed, are not 100% tested in production.

**Electrical Characteristics (78M15D)**

( $V_I = 23V$ ,  $I_O = 0.5A$ ,  $C_I = 0.33\mu F$ ,  $C_O = 0.1\mu F$ ,  $T_j = -40$  to  $125^\circ C$ , unless otherwise specified)

| Parameter                | Symbol                | Conditions                                   | Min                      | Typ  | Max   | Unit           |
|--------------------------|-----------------------|--|--------------------------|------|-------|----------------|
| Output Voltage           | $V_O$                 | $T_j = 25^\circ C$ , $I_O = 5mA \sim 1A$     | 14.40                    | 15.0 | 15.60 | V              |
|                          |                       | $V_I = 17.5V \sim 30V$ , $I_O = 5mA \sim 1A$ | 14.25                    | 15.0 | 15.75 | V              |
| Line Regulation ⑭        | $\Delta V_O$          | $T_j = 25^\circ C$<br>$I_O = 0.5A$           | $V_I = 17.5V \sim 30V$   |      | 300   | mV             |
|                          |                       |  | $V_I = 20V \sim 26V$     |      | 150   |                |
| Load Regulation ⑭        | $\Delta V_O$          | $T_j = 25^\circ C$ ,                         | $I_O = 5mA \sim 1A$      |      | 300   | mV             |
|                          |                       |  | $I_O = 0.25A \sim 0.75A$ |      | 150   |                |
| Quiescent Current        | $I_Q$                 | $T_j = 25^\circ C$                           |                          |      | 8.0   | mA             |
| Quiescent Current Change | $\Delta I_Q$          | $I_O = 5mA \sim 1A$                          |                          |      | 0.5   | mA             |
|                          |                       | $V_I = 17.5V \sim 30V$                       |                          |      | 1.0   |                |
| Output Voltage Drift ⑮   | $\Delta V / \Delta T$ | $I_O = 5mA$                                  |                          | -1.0 |       | mV/ $^\circ C$ |
| Output Noise Voltage     | $V_N$                 | $10Hz \leq f \leq 100KHz$                    |                          | 90   |       | $\mu V/V_O$    |
| Ripple Rejection ⑮       | RR                    | $f = 120Hz$ , $V_I = 18.5V \sim 28.5V$       | 54                       | 70   |       | dB             |
| Output Resistance ⑮      | $R_O$                 | $f = 1kHz$                                   |                          | 19   |       | m $\Omega$     |
| Short Circuit Current    | $I_{SC}$              | $T_j = 25^\circ C$ , $V_I = 30V$             |                          | 230  |       | mA             |
| Peak Out Current ⑮       | $I_{PK}$              | $T_j = 25^\circ C$                           |                          | 1.8  |       | A              |
| Dropout Voltage          | $V_d$                 | $T_j = 25^\circ C$ , $I_O = 0.5A$            |                          | 2.0  |       | V              |

**Note 14:** Load and line regulation are specified at constant junction temperature. Changes in  $V_O$  due to heating effects must be taken into account separately. Pulse testing with low duty is used.

**Note 15:** These parameters, although guaranteed, are not 100% tested in production.



**Electrical Characteristics (78M18D)**

( $V_I = 27V$ ,  $I_O = 0.5A$ ,  $C_I = 0.33\mu F$ ,  $C_O = 0.1\mu F$ ,  $T_j = -40$  to  $125^\circ C$ , unless otherwise specified)

| Parameter                | Symbol                | Conditions                                 | Min                      | Typ  | Max   | Unit           |
|--------------------------|-----------------------|--|--------------------------|------|-------|----------------|
| Output Voltage           | $V_O$                 | $T_j = 25^\circ C$ , $I_O = 5mA \sim 1A$   | 17.28                    | 18.0 | 18.72 | V              |
|                          |                       | $V_I = 21V \sim 30V$ , $I_O = 5mA \sim 1A$ | 17.10                    | 18.0 | 18.90 | V              |
| Line Regulation ⑩        | $\Delta V_O$          | $T_j = 25^\circ C$<br>$I_O = 0.5A$         | $V_I = 21V \sim 30V$     |      | 360   | mV             |
|                          |                       |  | $V_I = 24V \sim 26V$     |      | 180   |                |
| Load Regulation ⑩        | $\Delta V_O$          | $T_j = 25^\circ C$ ,                       | $I_O = 5mA \sim 1A$      |      | 300   | mV             |
|                          |                       |  | $I_O = 0.25A \sim 0.75A$ |      | 150   |                |
| Quiescent Current        | $I_Q$                 | $T_j = 25^\circ C$                         |                          |      | 8.0   | mA             |
| Quiescent Current Change | $\Delta I_Q$          | $I_O = 5mA \sim 1A$                        |                          |      | 0.5   | mA             |
|                          |                       | $V_I = 21V \sim 30V$                       |                          |      | 1.0   |                |
| Output Voltage Drift ⑪   | $\Delta V / \Delta T$ | $I_O = 5mA$                                |                          | -1.0 |       | mV/ $^\circ C$ |
| Output Noise Voltage     | $V_N$                 | $10Hz \leq f \leq 100KHz$                  |                          | 110  |       | $\mu V/V_O$    |
| Ripple Rejection ⑫       | RR                    | $f = 120Hz$ , $V_I = 22V \sim 30V$         | 53                       | 69   |       | dB             |
| Output Resistance ⑬      | $R_O$                 | $f = 1kHz$                                 |                          | 22   |       | m $\Omega$     |
| Short Circuit Current    | $I_{SC}$              | $T_j = 25^\circ C$ , $V_I = 30V$           |                          | 230  |       | mA             |
| Peak Out Current ⑭       | $I_{PK}$              | $T_j = 25^\circ C$                         |                          | 1.8  |       | A              |
| Dropout Voltage          | $V_d$                 | $T_j = 25^\circ C$ , $I_O = 0.5A$          |                          | 2.0  |       | V              |

**Note 16:** Load and line regulation are specified at constant junction temperature. Changes in  $V_O$  due to heating effects must be taken into account separately. Pulse testing with low duty is used.

**Note 17:** These parameters, although guaranteed, are not 100% tested in production.

**Electrical Characteristics (78M24D)**

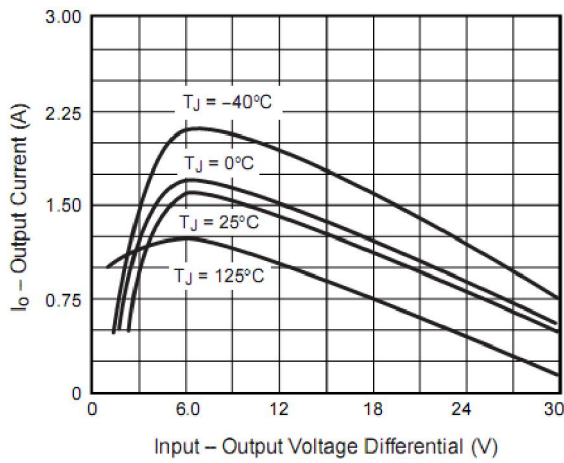
( $V_I = 33V$ ,  $I_O = 0.5A$ ,  $C_I = 0.33\mu F$ ,  $C_O = 0.1\mu F$ ,  $T_J = -40$  to  $125^\circ C$ , unless otherwise specified)

| Parameter                | Symbol                | Conditions                                 | Min                      | Typ  | Max   | Unit           |
|--------------------------|-----------------------|--|--------------------------|------|-------|----------------|
| Output Voltage           | $V_O$                 | $T_J = 25^\circ C$ , $I_O = 5mA \sim 1A$   | 23.04                    | 24.0 | 24.96 | V              |
|                          |                       | $V_I = 27V \sim 38V$ , $I_O = 5mA \sim 1A$ | 22.80                    | 24.0 | 25.20 | V              |
| Line Regulation ⑱        | $\Delta V_O$          | $T_J = 25^\circ C$<br>$I_O = 0.5A$         | $V_I = 27V \sim 38V$     |      | 480   | mV             |
|                          |                       |  | $V_I = 30V \sim 36V$     |      | 240   |                |
| Load Regulation ⑱        | $\Delta V_O$          | $T_J = 25^\circ C$ ,                       | $I_O = 5mA \sim 1A$      |      | 480   | mV             |
|                          |                       |  | $I_O = 0.25A \sim 0.75A$ |      | 240   |                |
| Quiescent Current        | $I_Q$                 | $T_J = 25^\circ C$                         |                          |      | 8.0   | mA             |
| Quiescent Current Change | $\Delta I_Q$          | $I_O = 5mA \sim 1A$                        |                          |      | 0.5   | mA             |
|                          |                       | $V_I = 27V \sim 38V$                       |                          |      | 1.0   |                |
| Output Voltage Drift ⑲   | $\Delta V / \Delta T$ | $I_O = 5mA$                                |                          | -1.5 |       | mV/ $^\circ C$ |
| Output Noise Voltage     | $V_N$                 | $10Hz \leq f \leq 100KHz$                  |                          | 60   |       | $\mu V/V_O$    |
| Ripple Rejection ⑲       | RR                    | $f = 120Hz$ , $V_I = 28V \sim 38V$         | 50                       | 67   |       | dB             |
| Output Resistance ⑲      | $R_O$                 | $f = 1kHz$                                 |                          | 28   |       | m $\Omega$     |
| Short Circuit Current    | $I_{SC}$              | $T_J = 25^\circ C$ , $V_I = 35V$           |                          | 230  |       | mA             |
| Peak Out Current ⑲       | $I_{PK}$              | $T_J = 25^\circ C$                         |                          | 1.8  |       | A              |
| Dropout Voltage          | $V_d$                 | $T_J = 25^\circ C$ , $I_O = 0.5A$          |                          | 2.0  |       | V              |

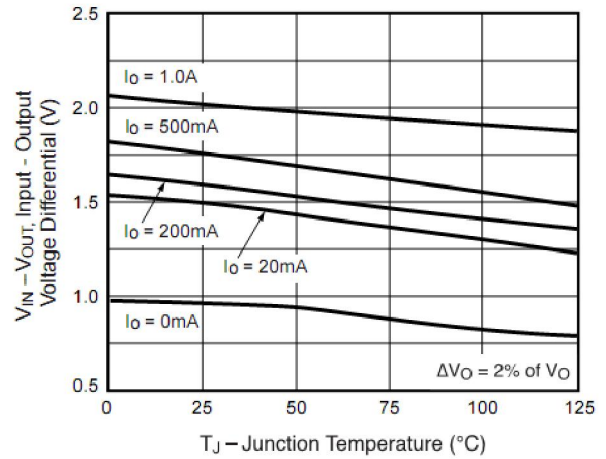
**Note 18:** Load and line regulation are specified at constant junction temperature. Changes in  $V_O$  due to heating effects must be taken into account separately. Pulse testing with low duty is used.

**Note 19:** These parameters, although guaranteed, are not 100% tested in production.

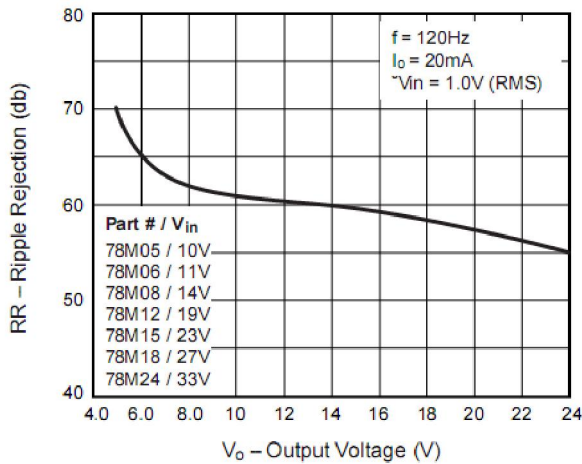
Typical Characteristics



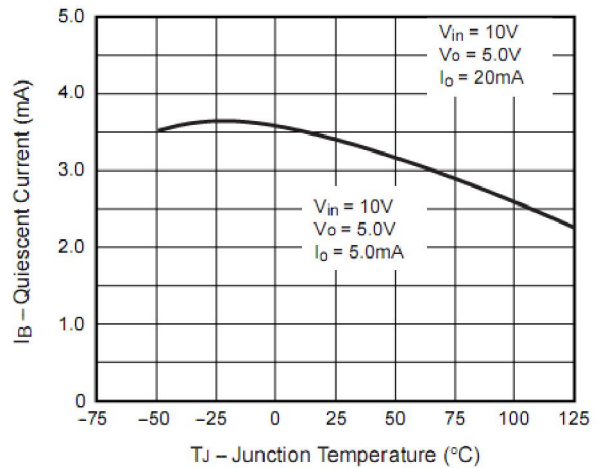
**Figure 1. Peak Output Current**



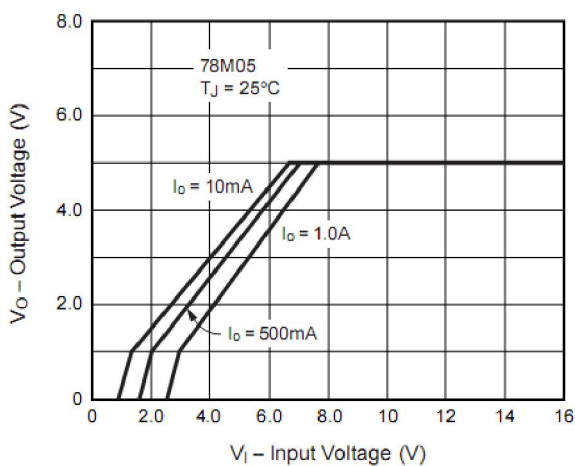
**Figure 2. Dropout Voltage vs. Junction Temperature**



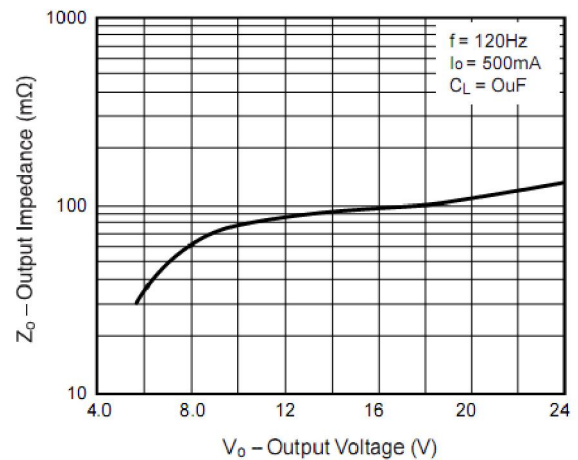
**Figure 3. Ripple Rejection Ratio vs. Output Voltage**



**Figure 4. Quiescent Current vs. Junction Temperature**

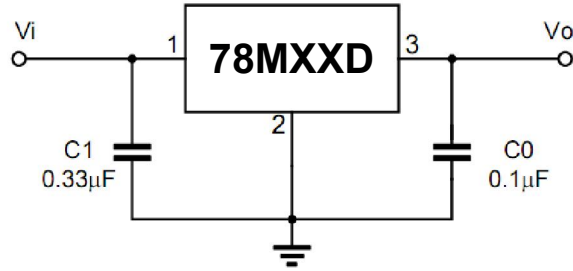


**Figure 8. Output Voltage vs. Input Voltage**



**Figure 9. Output Impedance (mΩ) vs. Output Voltage**

**Application circuit**



Note 1: To specify an output voltage, substitute voltage value for "MXX".

Note 2: Bypass capacitors are recommended for optimum stability and transient response and should be located as close as possible to the regulators.

**Package Dimensions**  
**TO-220AB**

| Symbol | Millimeter |       | Inches |       |
|--------|------------|-------|--------|-------|
|        | Min.       | Max.  | Min.   | Max.  |
| A      | 4.34       | 4.67  | 0.171  | 0.184 |
| A1     | 2.52       | 2.82  | 0.099  | 0.111 |
| b      | 0.71       | 0.91  | 0.028  | 0.036 |
| b1     | 1.17       | 1.37  | 0.046  | 0.054 |
| c      | 0.30       | 0.50  | 0.012  | 0.020 |
| c1     | 1.17       | 1.37  | 0.046  | 0.054 |
| D      | 9.90       | 10.20 | 0.390  | 0.402 |
| E      | 8.50       | 8.90  | 0.335  | 0.350 |
| E1     | 12.00      | 12.50 | 0.472  | 0.492 |
| e      | 2.44       | 2.64  | 0.096  | 0.104 |
| e1     | 4.88       | 5.28  | 0.192  | 0.208 |
| F      | 2.60       | 2.80  | 0.102  | 0.110 |
| L      | 13.20      | 13.80 | 0.520  | 0.543 |
| L1     | 3.80       | 4.20  | 0.150  | 0.165 |
| Φ      | 3.60       | 3.96  | 0.142  | 0.156 |

Package Dimensions

TO-252

| Symbol | Millimeter |       | Inches |       |
|--------|------------|-------|--------|-------|
|        | Min.       | Max.  | Min.   | Max.  |
| A      | 2.20       | 2.50  | 0.087  | 0.098 |
| A1     | 0.00       | 0.12  | 0.000  | 0.005 |
| A2     | 2.20       | 2.40  | 0.087  | 0.094 |
| B      | 1.20       | 1.60  | 0.047  | 0.063 |
| b      | 0.50       | 0.70  | 0.020  | 0.028 |
| b1     | 0.70       | 0.90  | 0.028  | 0.035 |
| c      | 0.40       | 0.60  | 0.016  | 0.024 |
| c1     | 0.40       | 0.60  | 0.016  | 0.024 |
| D      | 6.35       | 6.65  | 0.250  | 0.262 |
| D1     | 5.20       | 5.40  | 0.205  | 0.213 |
| E      | 5.40       | 5.70  | 0.213  | 0.224 |
| e      | 2.20       | 2.40  | 0.087  | 0.094 |
| e1     | 4.40       | 4.80  | 0.173  | 0.189 |
| L      | 9.60       | 10.20 | 0.378  | 0.402 |
| L1     | 2.70       | 3.10  | 0.106  | 0.122 |
| L2     | 1.40       | 1.80  | 0.055  | 0.071 |
| L3     | 0.90       | 1.50  | 0.035  | 0.059 |

