

**Digital Transistors (Built-in Resistors)**

DIGITAL TRANSISTOR(NPN)

• **Equivalent Circuit**

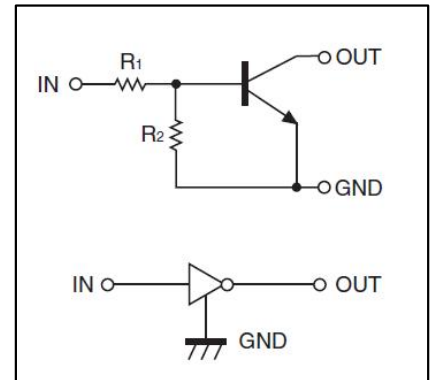

**FEATURES**

- Built-in bias resistors enable the configuration of an inverter circuit without connecting external input resistors(see equivalent circuit)
- The bias resistors consist of thin-film resistors with complete isolation to allow negative biasing of the input.They also have the advantage of almost completely eliminating parasitic effects
- Only the on/off conditions need to be set for operation, making device design easy

**MARKING: 23**

**PIN CONNENCTIONS and MARKING**

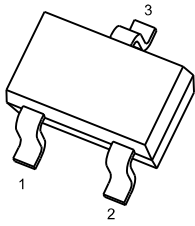
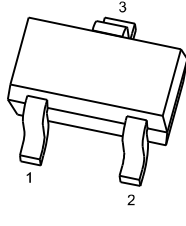
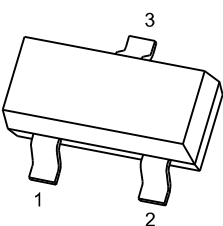
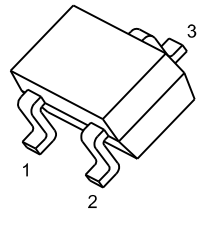
<p><b>DTC143EUA</b></p>  <p><b>SOT-323</b></p> <p>1. IN 2. GND 3. OUT</p>	<p><b>DTC143EE</b></p>  <p><b>SOT-523</b></p> <p>1. IN 2. GND 3. OUT</p>
<p><b>DTC143ECA</b></p>  <p><b>SOT-23</b></p> <p>1. IN 2. GND 3. OUT</p>	<p><b>DTC143EKA</b></p>  <p><b>SOT23-3L</b></p> <p>1. IN 2. GND 3. OUT</p>

**MAXIMUM RATINGS**( $T_a=25^{\circ}\text{C}$  unless otherwise noted)

Symbol	Parameter	Limits(DTC143E□)					Unit
			E	UA	CA	KA	
$V_{CC}$	Supply Voltage	50					V
$V_{IN}$	Input Voltage	-10~+30					V
$I_o$	Output Current	100					mA
$P_D$	Power Dissipation		150	200	200	200	mW
$T_j$	Junction Temperature	150					$^{\circ}\text{C}$
$T_{stg}$	Storage Temperature	-55~+150					$^{\circ}\text{C}$

**ELECTRICAL CHARACTERISTICS** ( $T_a=25^{\circ}\text{C}$  unless otherwise specified)

Parameter	Symbol	Conditions	Min	Typ	Max	Unit
Input voltage	$V_{I(off)}$	$V_{CC}=5V, I_o=100\mu\text{A}$	0.5			V
	$V_{I(on)}$	$V_o=0.3V, I_o=20\text{mA}$			3	V
Output voltage	$V_{O(on)}$	$I_o/I_i=10\text{mA}/0.5\text{mA}$			0.3	V
Input current	$I_i$	$V_i=5V$			1.8	mA
Output current	$I_{O(off)}$	$V_{CC}=50V, V_i=0$			0.5	$\mu\text{A}$
DC current gain	$G_i$	$V_o=5V, I_o=10\text{mA}$	20			
Input resistance	$R_1$		3.29	4.7	6.11	k $\Omega$
Resistance ratio	$R_2/R_1$		0.8	1	1.2	
Transition frequency	$f_T$	$V_o=10V, I_o=5\text{mA}, f=100\text{MHz}$		250		MHz

## Typical Characteristics

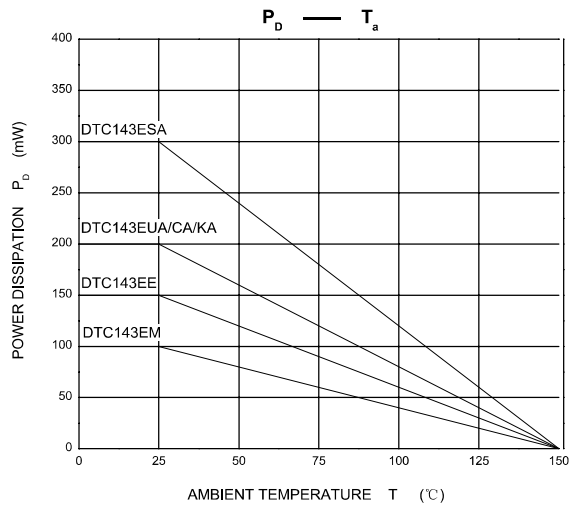
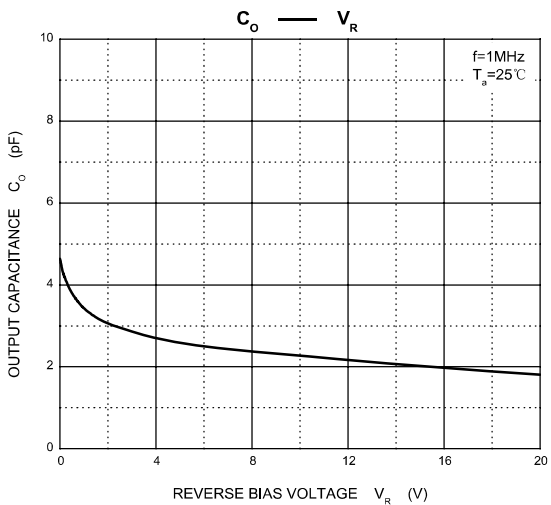
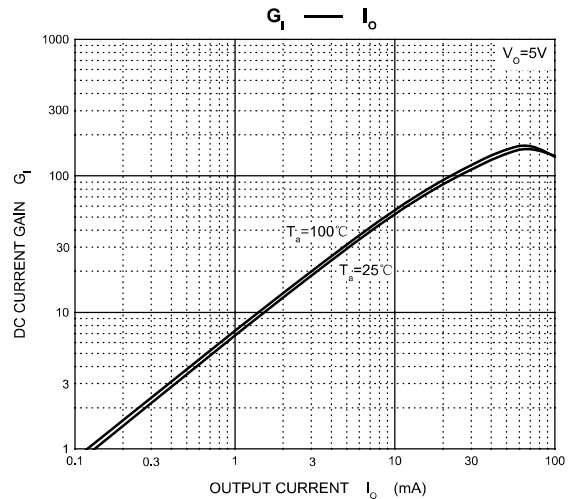
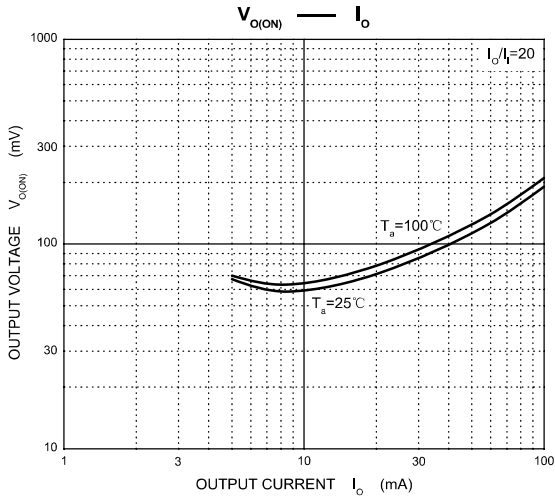
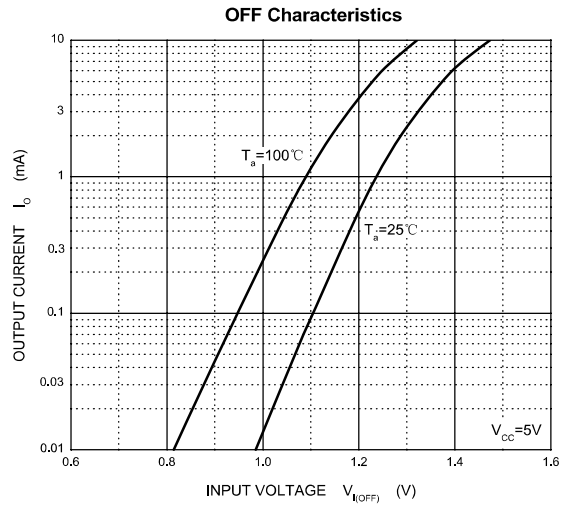
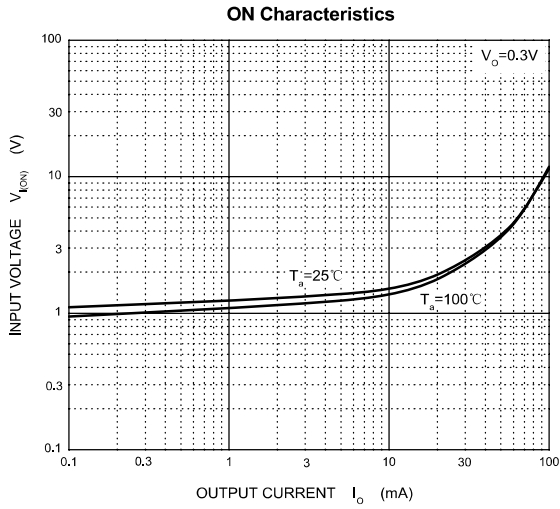

Package Outline

SOT-523

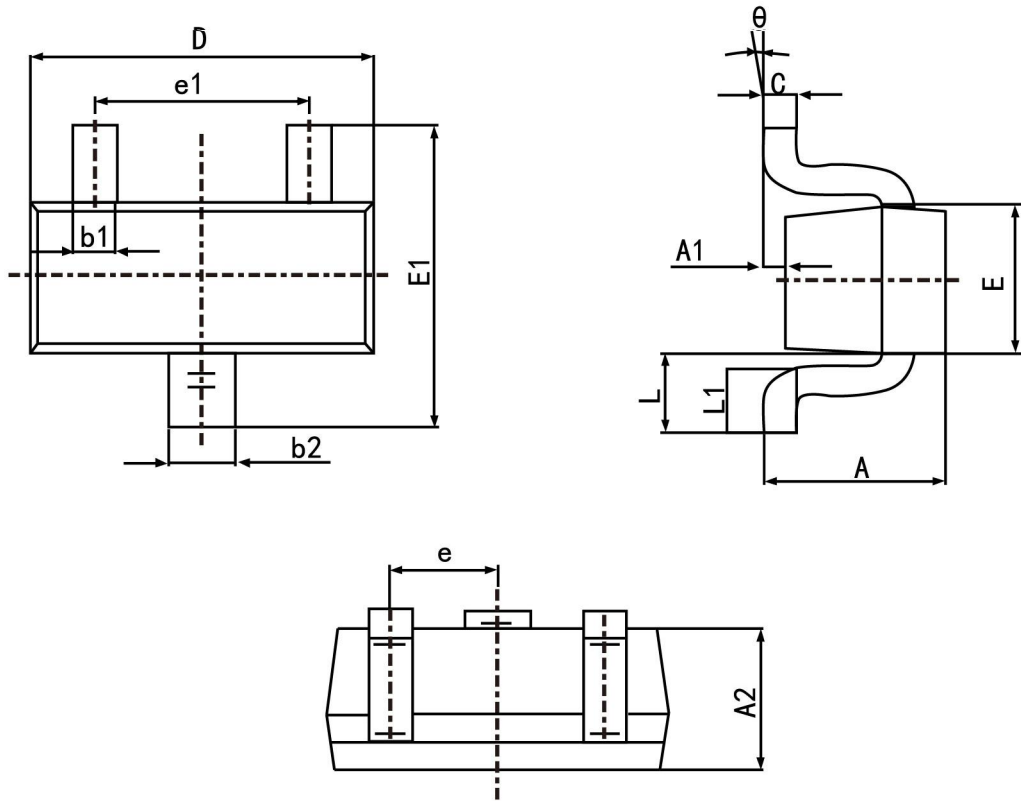

Symbol	Dimension in Millimeters	
	Min	Max
A	0.700	0.900
A1	0.000	0.100
A2	0.700	0.800
b1	0.150	0.250
b2	0.250	0.350
c	0.100	0.200
D	1.500	1.700
E	0.700	0.900
E1	1.450	1.750
e	0.500	TYP.
e1	0.900	1.100
L	0.400 REF.	
L1	0.260	0.460
$\theta$	0°	8°

Summary of Packing Options

Package	Packing Description	Packing Quantity	Industry Standard
SOT-523	Tape/Reel, 7" reel	3000	EIA-481-1

Package Outline

SOT-323

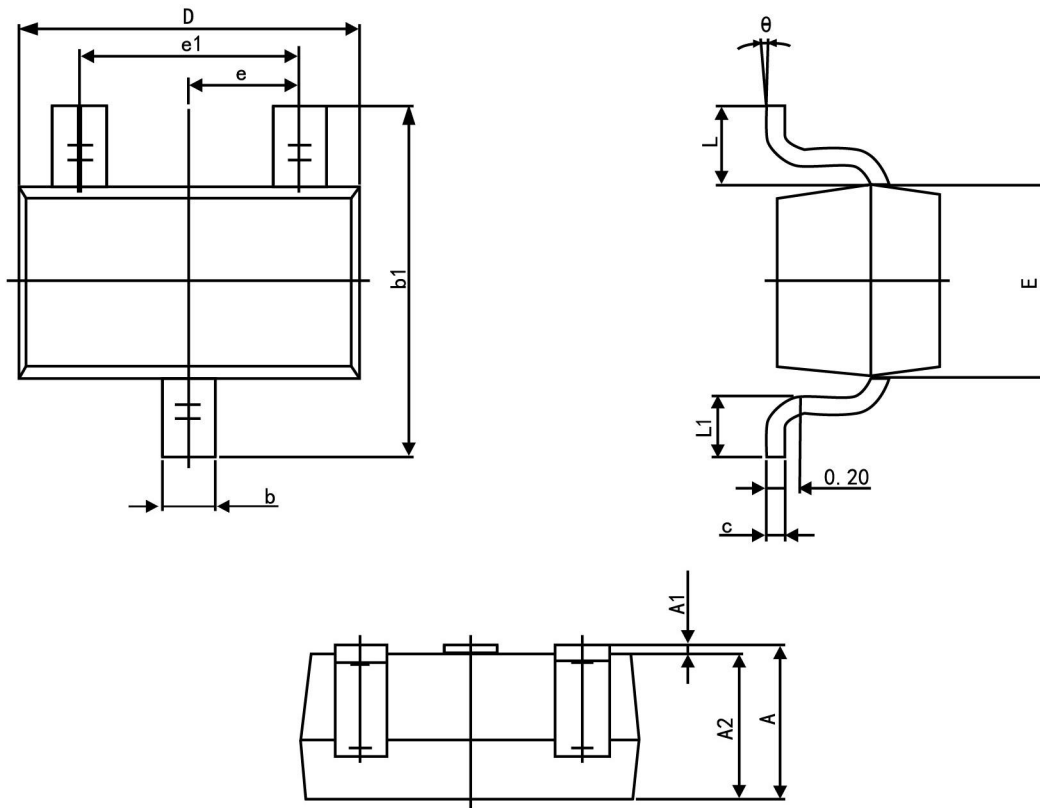

Symbol	Dimension in Millimeters	
	Min	Max
A	0.900	1.100
A1	0.000	0.100
A2	0.900	1.000
b	0.200	0.400
c	0.080	0.150
D	2.000	2.200
E	1.150	1.350
E1	2.150	2.450
e	0.650 TYP.	
e1	1.200	1.400
L	0.525 REF.	
L1	0.260	0.460
θ	0°	8°

Summary of Packing Options

Package	Packing Description	Packing Quantity	Industry Standard
SOT-323	Tape/Reel,7"reel	3000	EIA-481-1

Package Outline

SOT23-3L

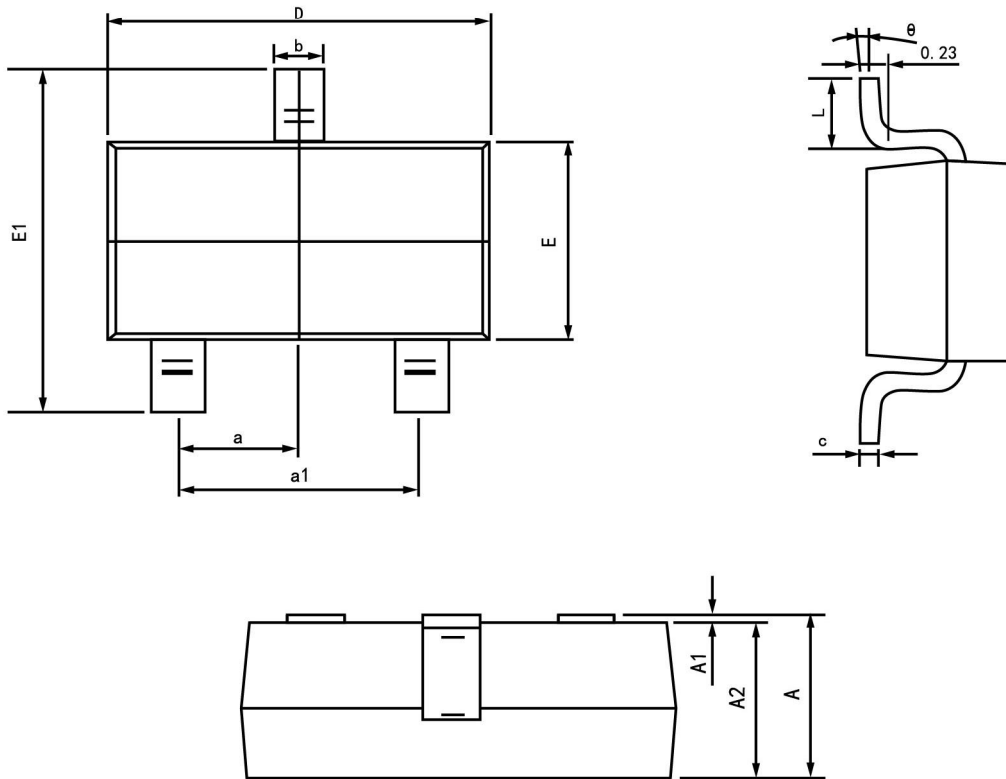

Symbol	Dimension in Millimeters	
	Min	Max
A	1.050	1.250
A1	0.000	0.100
A2	1.050	1.150
b	0.300	0.500
c	0.100	0.200
D	2.820	3.020
E	1.500	1.700
E1	2.650	2.950
e	0.950 (Basic)	
e1	1.800	2.000
L	0.300	0.600
θ	0°	8°

Summary of Packing Options

Package	Packing Description	Packing Quantity	Industry Standard
SOT23-3L	Tape/Reel,7"reel	3000	EIA-481-1

Package Outline

SOT-23

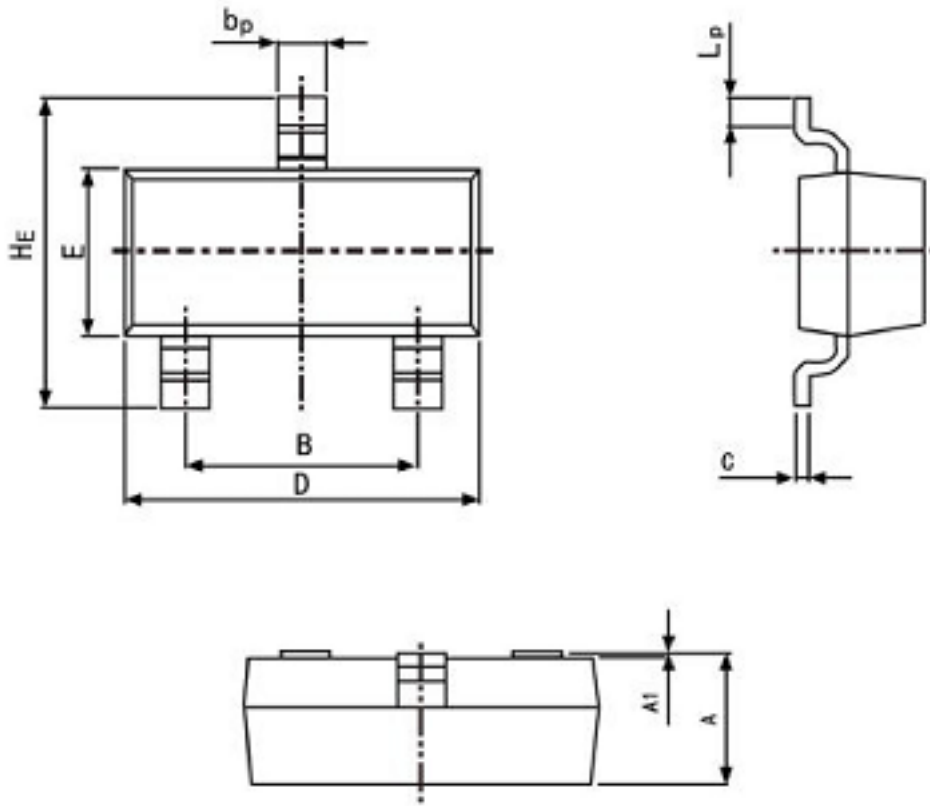

Symbol	Dimension in Millimeters	
	Min	Max
A	0.95	1.40
B	1.78	2.04
$b_p$	0.35	0.50
C	0.08	0.19
D	2.70	3.10
E	1.20	1.65
HE	2.20	3.00
$A_1$	0.100	0.013
$L_p$	0.20	0.50

Summary of Packing Options

Package	Packing Description	Packing Quantity	Industry Standard
SOT-23	Tape/Reel, 7" reel	3000	EIA-481-1