

Surface mount transient voltage suppressor power 400 watts
Stand-Off Voltage: 6.8V

FEATURES

- ◆For surface mounted applications in order to optimize board space.
- ◆Low profile package.
- ◆Glass passivated junction.
- ◆Low inductance.
- ◆Plastic package has Underwriters Laboratory Flammability.

Pinning

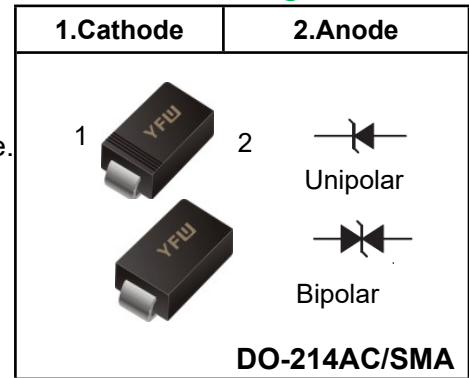

MECHANICAL DATA

- ◆Case: DO-214AC/SMA
- ◆Terminals: Solderable per MIL-STD-750, Method 2026
- ◆Approx. Weight:0.07g /0.002oz

Maximum Ratings and Electrical characteristics

Ratings at 25 ambient temperature unless o °C therwise specified.

Parameter	Symbol	Value	Unit
Peak Pulse Power Dissipation on TA=25°C (Note 1,2,5, Fig1)	P_{PPM}	400	W
Peak Forward Surge Current (Note3, Note4)	I_{FSM} (UNI)	60	A
Peak Pulse Current on 10/1000 us waveform (Note 1) Fig 3	I_{PPM}	see Table 1	A
ESD Voltage per IEC6100-4-2	Contact	±30	kV
	Air	±30	
Typical Junction Capacitance at VR=4V, f=1MHz	C_j	390	pF
Typical Thermal Resistance Junction to Ambient(Note 2)	R_{θJA}	120	°C/W
Operating Junction Temperature and Storage Temperature Range	T_J,T_{STG}	-55 to +150	°C

NOTES:

1. Non-repetitive current pulse, per Fig.3 and derated above T_A = 25°C per Fig. 2.
2. Mounted on 5mm² copper pads to each terminal.
3. Peak Forward Surge Current : 8.3ms single half sine-wave Superimposed on rated load (JEDEC method).
4. Peak pulse power waveform is 10/1000µS.

Characteristics at Ta = 25°C

Table 1

Type		Reverse Stand-off Voltage	Breakdown Voltage		Test Current	Reverse Leakage	Max. Clamp Voltage	Peak Pulse Current	Package	
			V _{BR} @ I _T						SMA	
		V _{RWM}	Min	Max	I _T	I _R @ V _{RWM}	V _C @ I _{PP}	I _{PP}	Device Marking Ccode	
UNI	BI	V	V	V	mA	μA	V	A	UNI	BI
SMAJ6V8A	SMAJ6V8CA	5.8	6.45	7.14	10	1000	10.5	39	6V8A	6V8C

Fig.1 Peak Pulse Power Rating Curve

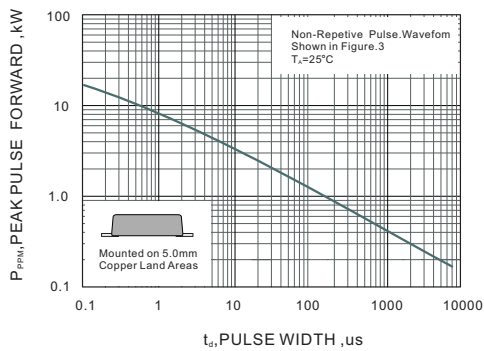

Fig.2 Forward Current Derating Curve

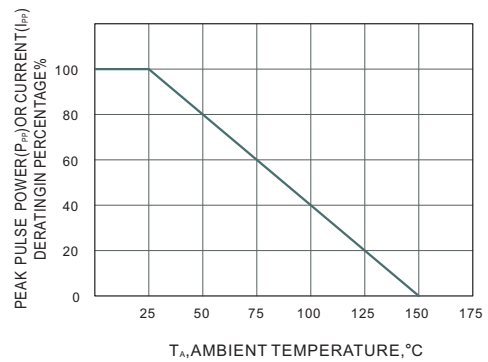

Fig.3 Pulse Waveform

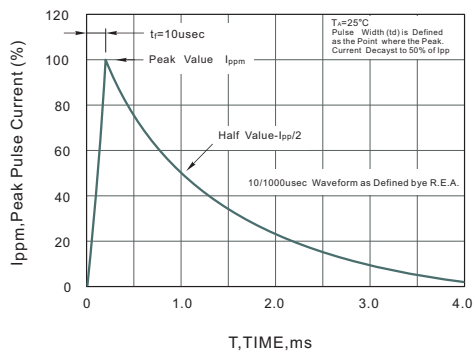
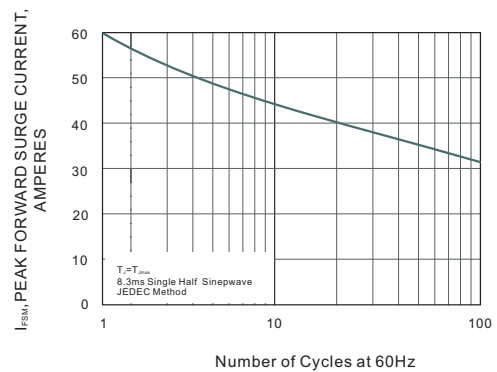
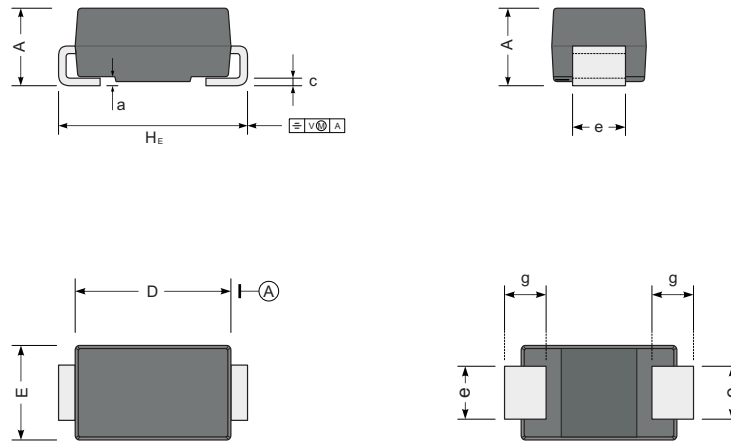

Fig.4 Maximum Non-Repetitive Peak Forward Surge Current



Package Outline DO-214AC SMA

Plastic surface mounted package; 2 leads



UNIT		A	D	E	H _E	c	e	g	a
mm	max	2.42	4.5	2.80	5.2	0.31	1.6	1.5	0.3
	min	1.98	4.0	2.54	4.7	0.15	1.3	0.9	
mil	max	96	181	110	205	12	63	59	12
	min	78	157	100	185	6	51	35	

The recommended mounting pad size

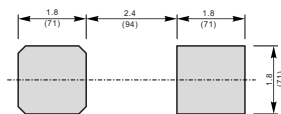

Unit : $\frac{\text{mm}}{\text{(mil)}}$

Summary of Packing Options

Package	Packing Description	Packing Quantity	Industry Standard
DO-214AC SMA	Tape/Reel, 11" reel	5000	EIA-481-1
	Tape/Reel, 7" reel	2000	EIA-481-1