

Surface mount transient voltage suppressor power 200 watts

Reverse Voltage -5.0V to 440 V

Forward Current - 20 A

FEATURES

- ◆ For surface mounted applications in order to optimize board space.
- ◆ Low profile package
- ◆ Glass passivated junction
- ◆ Low inductance
- ◆ Plastic package has Underwriters Laboratory Flammability

MECHANICAL DATA

- ◆ Case: SOD-123FL
- ◆ Terminals: Solderable per MIL-STD-750, Method 2026
- ◆ Approx. Weight: 15mg/0.00048oz

Maximum Ratings and Electrical characteristics

Ratings at 25 °C ambient temperature unless otherwise specified.

Parameter	Symbol	Value	Unit
Peak Pulse Power Dissipation on TA=25°C (Note 1,2,5, Fig1)	P_{PPM}	200	W
Peak Forward Surge Current (Note 3)	I_{FSM} (UNI)	20	A
Peak Pulse Current on 10/1000 us waveform (Note 1 Fig)2	I_{PPM}	see Table 1	A
Steady State Power Dissipation (Note 4)	$P_{M(AV)}$	1	W
Operating Junction and Storage Range	T_J, T_{STG}	-55 to +150	°C
Typical Thermal Resistance	$R_{\theta JA}$	180	°C/W

NOTES

1. Non-repetitive current pulse per Fig 3 and derated above $T_a=25^\circ\text{C}$ per Fig 2
2. Mounted on 5mm² copper pads to each terminal
3. 8.3ms single half sinewave, or equivalent square wave duty cycle=4 pulses per minutes maximum
4. lead temperature at $T_l=75^\circ\text{C}$
5. Peak pulse powe. waveform is tp=10/1000us
6. A transient suppressor is selected according to the working peak reverse voltage(V_{RWM}), Which Should be equal to or greater than the DC or continuous peak operating voltage level

Pinning

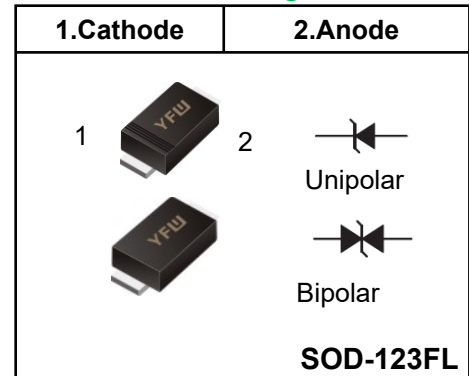

Characteristics at Ta = 25°C

Type		Marking		VRMW	Breakdown Voltage		Test	Reverse	Max.	Peak Pulse
					V _{BR} @ I _T		I _T	IR @ VRWM	VC @ IPP	IPP
					Min	Max				
Uni	Bi	Uni	Bi	V	V	V	mA	μA	V	A
SMF5.0A	SMF5.0CA	AE	CAE	5	6.4	7	10	400	9.2	21.7
SMF6.0A	SMF6.0CA	AG	CAG	6	6.67	7.37	10	400	10.3	19.4
SMF6.5A	SMF6.5CA	AK	CAK	6.5	7.22	7.98	10	250	11.2	17.9
SMF7.0A	SMF7.0CA	AM	CAM	7	7.78	8.6	10	100	12	16.7
SMF7.5A	SMF7.5CA	AP	CAP	7.5	8.33	9.21	1	50	12.9	15.5
SMF8.0A	SMF8.0CA	AR	CAR	8	8.89	9.83	1	25	13.6	14.7
SMF8.5A	SMF8.5CA	AT	CAT	8.5	9.44	10.4	1	10	14.4	13.9
SMF9.0A	SMF9.0CA	AV	CAV	9	10	11.1	1	5	15.4	13
SMF10A	SMF10CA	AX	CAX	10	11.1	12.3	1	2.5	17	11.8
SMF11A	SMF11CA	AZ	CAZ	11	12.2	13.5	1	2.5	18.2	11
SMF12A	SMF12CA	BE	CBE	12	13.3	14.7	1	2.5	19.9	10.1
SMF13A	SMF13CA	BG	CBG	13	14.4	15.9	1	1	21.5	9.3
SMF14A	SMF14CA	BK	CBK	14	15.6	17.2	1	1	23.2	8.6
SMF15A	SMF15CA	BM	CBM	15	16.7	18.5	1	1	24.4	8.2
SMF16A	SMF16CA	BP	CBP	16	17.8	19.7	1	1	26	7.7
SMF17A	SMF17CA	BR	CBR	17	18.9	20.9	1	1	27.6	7.2
SMF18A	SMF18CA	BT	CBT	18	20	22.1	1	1	29.2	6.8
SMF20A	SMF20CA	BV	CBV	20	22.2	24.5	1	1	32.4	6.2
SMF22A	SMF22CA	BX	CBX	22	24.4	26.9	1	1	35.5	5.6
SMF24A	SMF24CA	BZ	CBZ	24	26.7	29.5	1	1	38.9	5.1
SMF26A	SMF26CA	CE	CCE	26	28.9	31.9	1	1	42.1	4.8
SMF28A	SMF28CA	CG	CCG	28	31.1	34.4	1	1	45.4	4.4
SMF30A	SMF30CA	CK	CCK	30	33.3	36.8	1	1	48.4	4.1
SMF33A	SMF33CA	CM	CCM	33	36.7	40.6	1	1	53.3	3.8
SMF36A	SMF36CA	CP	CCP	36	40	44.2	1	1	58.1	3.4
SMF40A	SMF40CA	CR	CCR	40	44.4	49.1	1	1	64.5	3.1
SMF43A	SMF43CA	CT	CCT	43	47.8	52.8	1	1	69.4	2.9
SMF45A	SMF45CA	CV	CCV	45	50	55.3	1	1	72.7	2.8
SMF48A	SMF48CA	CX	CCX	48	53.3	58.9	1	1	77.4	2.6
SMF51A	SMF51CA	CZ	CCZ	51	56.7	62.7	1	1	82.4	2.4
SMF54A	SMF54CA	DE	CDE	54	60	66.3	1	1	87.1	2.3
SMF58A	SMF58CA	DG	CDG	58	64.4	71.2	1	1	93.6	2.1
SMF60A	SMF60CA	DK	CDK	60	66.7	73.7	1	1	96.8	1.8
SMF64A	SMF64CA	DM	CDM	64	71.1	78.6	1	1	103	1.7
SMF70A	SMF70CA	DP	CDP	70	77.8	86	1	1	113	1.5
SMF75A	SMF75CA	DR	CDR	75	83.3	92.1	1	1	121	1.4
SMF78A	SMF78CA	DT	CDT	78	86.7	95.8	1	1	126	
SMF85A	SMF85CA	DV	CDV	85	94.4	104	1	1	137	1.3
SMF90A	SMF90CA	DX	CDX	90	100	111	1	1	146	1.2
SMF100A	SMF100CA	DZ	CDZ	100	111	123	1	1	162	1.1
SMF110A	SMF110CA	EE	CEE	110	122	135	1	1	177	1
SMF120A	SMF120CA	EG	CEG	120	133	147	1	1	193	0.9
SMF130A	SMF130CA	EK	CEK	130	144	159	1	1	209	0.8
SMF150A	SMF150CA	EM	CEM	150	167	185	1	1	243	0.7
SMF160A	SMF160CA	EP	CEP	160	178	197	1	1	259	
SMF170A	SMF170CA	ER	CER	170	189	209	1	1	275	0.6
SMF180A	SMF180CA	ET	CET	180	201	222	1	1	292	0.5
SMF190A	SMF190CA	EV	CEV	190	211	232	1	1	308	
SMF200A	SMF200CA	EX	CEX	200	224	247	1	1	324	
SMF220A	SMF220CA	E22	CE22	220	246	272	1	1	356	
SMF250A	SMF250CA	E25	CE25	250	279	309	1	1	405	
SMF300A	SMF300CA	E30	CE30	300	335	371	1	1	486	0.45
SMF350A	SMF350CA	E35	CE35	350	391	432	1	1	567	0.4
SMF400A	SMF400CA	E40	CE40	400	447	494	1	1	648	0.35
SMF440A	SMF440CA	E44	CE44	440	492	543	1	1	713	0.3

Fig.1 Peak Pulse Power Rating Curve

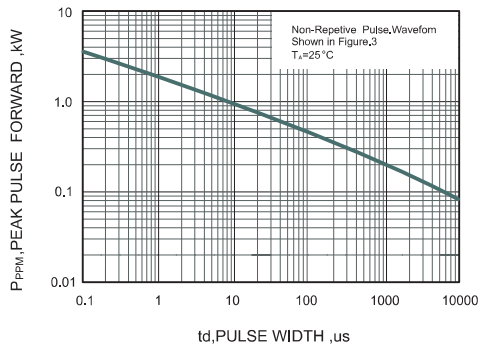

Fig.2 Forward Current Derating Curve

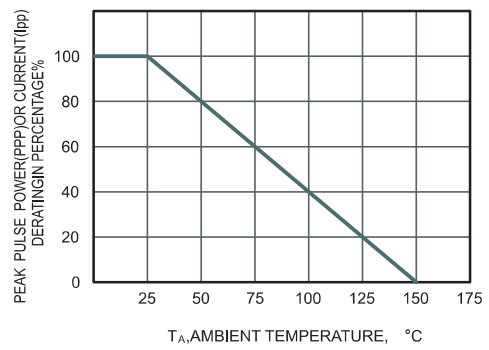

Fig.3 Pulse Waveform

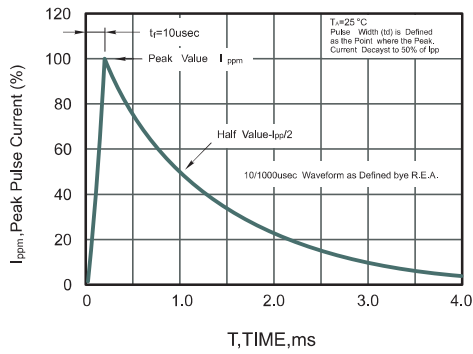
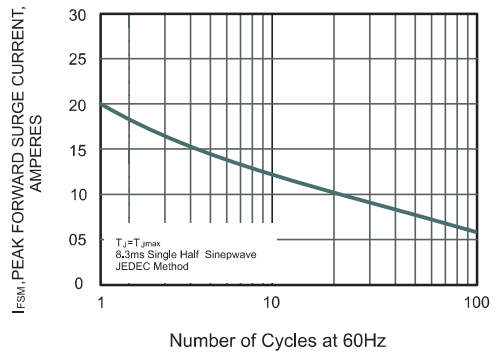
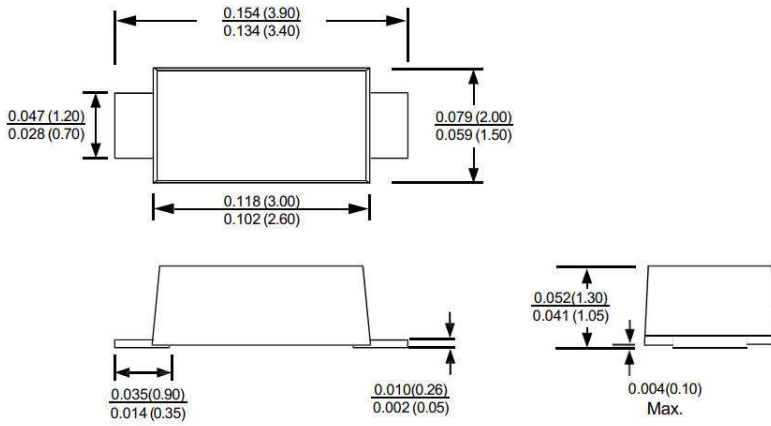

Fig.4 Maximum Non-Repetitive Peak Forward Surge Current



Package Outline

SOD-123FL



Mounting Pad Layout

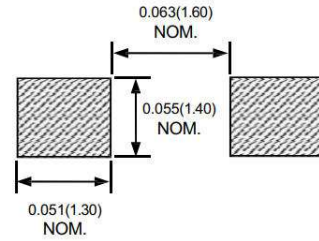

Summary of Packing Options

Package	Packing Description	Packing Quantity	Industry Standard
SOD-123FL	Tape/Reel, 13" reel	10000	EIA-481-1
	Tape/Reel, 7" reel	3000	EIA-481-1