

VOLTAGE RANGE: 100 - 600V

CURRENT: 16A

Features

- Glass passivated chip junctions
- Super fast recovery time for switching mode application
- High Forward Surge Capability
- Low Reverse Current
- Lead free in compliance with EU RoHS 2011/65/EU directive

Mechanical Data

- Circuit figure: Common cathode
- Leads: Solderable per mil-std-202, Method 208
- Polarity: as marked
- Mounting torque: 5 in-lbs maximum
- Terminals: Puretin plated
- Weight: ITO-220AB 1.70 grams

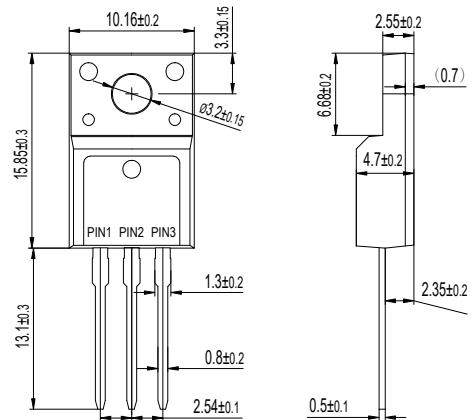
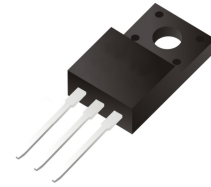

ITO-220AB

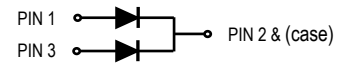

Maximum Ratings And Electrical Characteristics $T_A = 25^\circ\text{C}$

RATINGS	SYMBOL	SFF 1601CT	SFF 1602CT	SFF 1603CT	SFF 1604CT	SFF 1605CT	SFF 1606CT	UNIT
Maximum repetitive reverse voltage	VRRM	100	200	300	400	500	600	V
Maximum RMS voltage	VRMS	70	140	210	280	350	420	V
Maximum DC blocking voltage	VDC	100	200	300	400	500	600	V
Maximum average forward current	IAV	16						A
Peak forward surge current, 8.3ms single half sine-wave superimposed on rated load	IFSM	250						A
Typical thermal resistance per diode (Note 1)	R θ -JC	4.0						$^\circ\text{C}/\text{W}$
Operating junction temperature range	TJ	-55 to +150						$^\circ\text{C}$
Storage temperature range	TSTG	-55 to +150						$^\circ\text{C}$
Typical forward voltage per leg at 8A	V _F	1.00		1.30		1.70		V
Maximum average reverse current at rated DC blocking voltage	I _R			5		250		μA
				250				
Typical reverse recovery time (Note 2)	T _{RR}	35						nS

Notes: 1. Thermal resistance from junction to case.
2. Test conditions: I_F=0.5A, I_R=1.0A, I_{RR}=0.25A.

FIG. 1 - TYPICAL FORWARD CURRENT DERATING CURVE

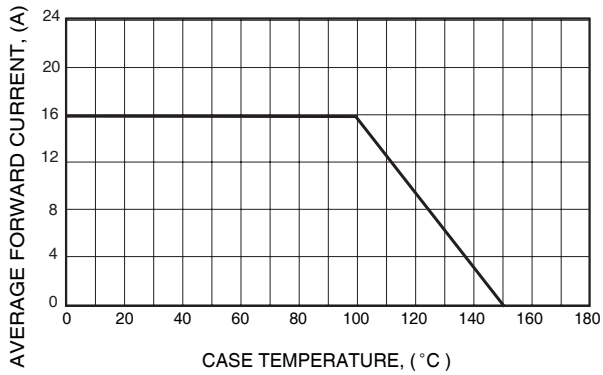

FIG. 3 - MAXIMUM NON-REPETITIVE FORWARD SURGE CURRENT

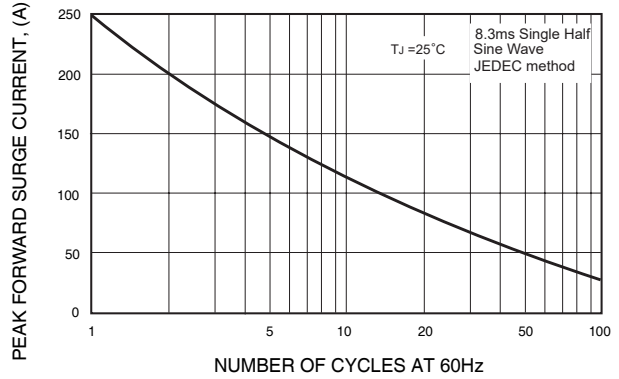

FIG. 4 - TYPICAL REVERSE CHARACTERISTICS

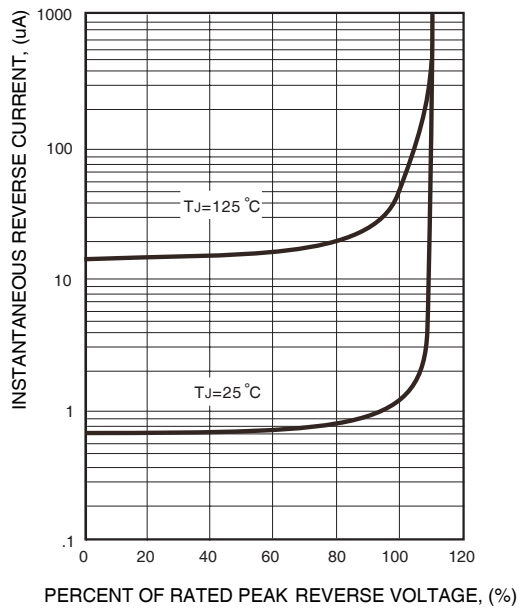

FIG. 2 - TYPICAL INSTANTANEOUS FORWARD CHARACTERISTICS

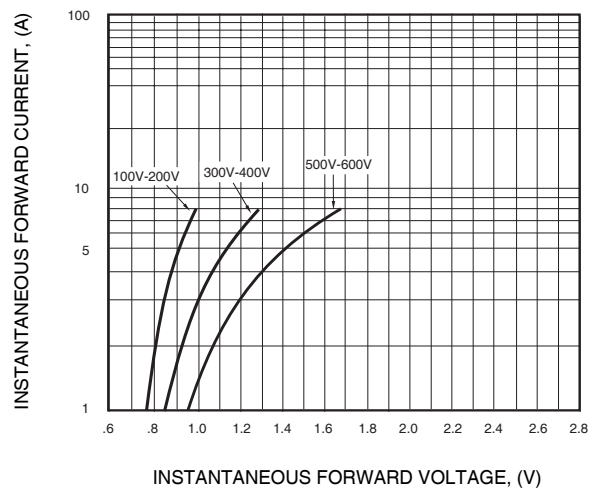
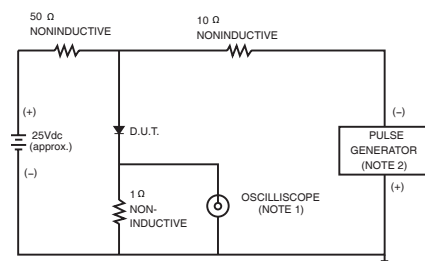

FIG.6- TEST CIRCUIT DIAGRAM AND REVERSE RECOVERY TIME CHARACTERISTICS



NOTES: 1. Rise Time= 7ns max., Input Impedance= 1 megohm, 22pF.
2. Rise Time= 10ns max., Source Impedance= 50 ohms.

