

VOLTAGE RANGE: 100 - 600V

CURRENT: 20A

Features

- Glass passivated chip junctions
- Super fast recovery time for switching mode application
- High Forward Surge Capability
- Low Reverse Current
- Lead free in compliance with EU RoHS 2011/65/EU directive

Mechanical Data

- Circuit figure: Common Cathode
- Leads: Solderable per mil-std-202, Method 208
- Polarity: as marked
- Mounting torque: 5 in-lbs maximum
- Terminals: Puretin plated
- Weight: TO-220AB 1.85 grams

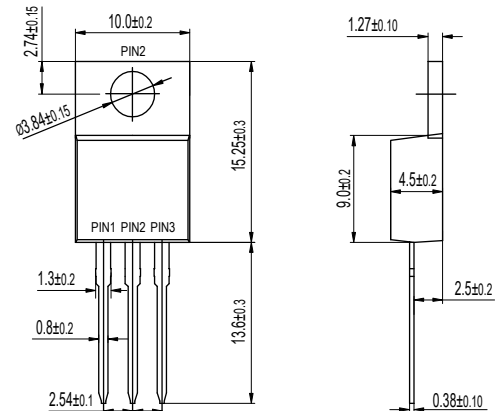
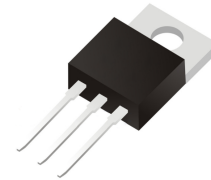

TO-220AB

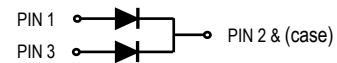

Maximum Ratings And Electrical Characteristics $T_A = 25^\circ\text{C}$

RATINGS	SYMBOL	SF 2001CT	SF 2002CT	SF 2003CT	SF 2004CT	SF 2005CT	SF 2006CT	UNIT
Maximum repetitive reverse voltage	V _{RRM}	100	200	300	400	500	600	V
Maximum RMS voltage	V _{RMS}	70	140	210	280	350	420	V
Maximum DC blocking voltage	V _{DC}	100	200	300	400	500	600	V
Maximum average forward current	I _{AV}	20						A
Peak forward surge current, 8.3ms single half sine-wave superimposed on rated load	I _{FSM}	300						A
Typical thermal resistance per diode(Note 1)	R _{θ-JC}	2.5						°C/W
Operating junction temperature range	T _J	-55 to +150						°C
Storage temperature range	T _{STG}	-55 to +150						°C
Typical forward voltage per leg at 10A	V _F	1.00	1.30		1.70		V	
Maximum average reverse current at rated DC blocking voltage T _J =25°C T _J =125°C	I _R	5 250						μA
Typical reverse recovery time(Note 2)	T _{RR}	35						nS

Notes: 1. Thermal resistance from junction to case.
2. Test conditions: I_F=0.5A, I_R=1.0A, I_{RR}=0.25A.

FIG. 1 - TYPICAL FORWARD CURRENT DERATING CURVE

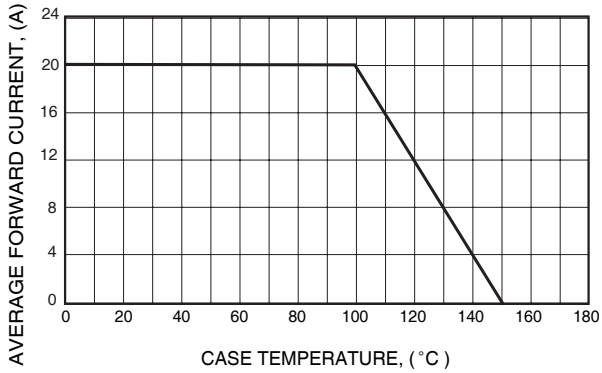

FIG. 3 - MAXIMUM NON-REPETITIVE FORWARD SURGE CURRENT

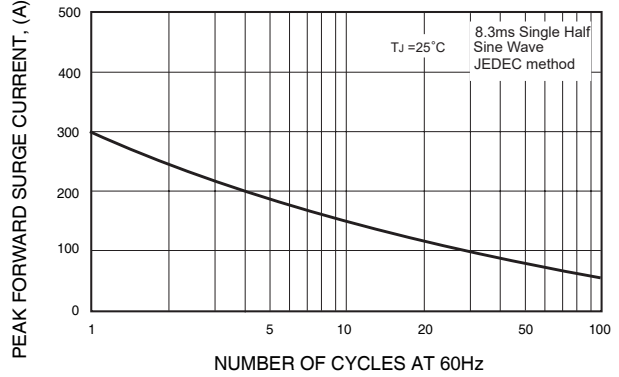

FIG. 4 - TYPICAL REVERSE CHARACTERISTICS

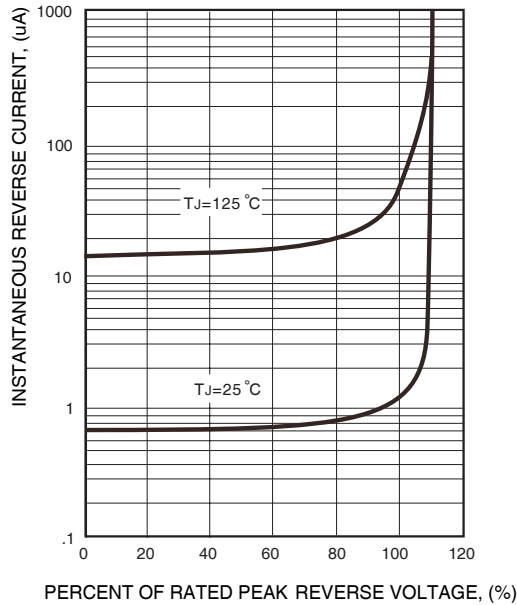

FIG. 2 - TYPICAL INSTANTANEOUS FORWARD CHARACTERISTICS

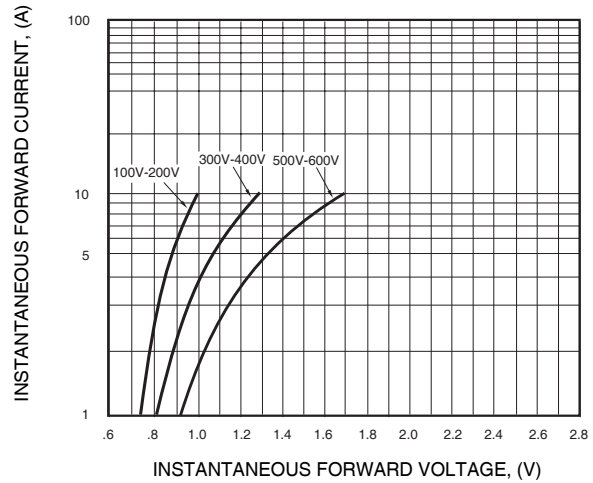
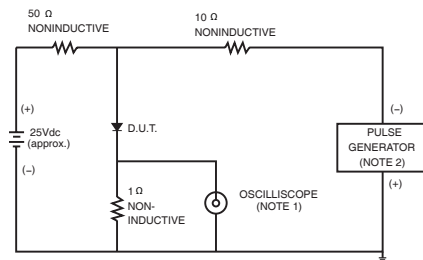

FIG.6- TEST CIRCUIT DIAGRAM AND REVERSE RECOVERY TIME CHARACTERISTICS



NOTES: 1. Rise Time= 7ns max., Input Impedance= 1 megohm, 22pF.
2. Rise Time= 10ns max., Source Impedance= 50 ohms.

