

VOLTAGE RANGE: 100 - 1000V

CURRENT: 10A

Features

- Glass passivated chip junctions
- Low reverse current operation
- High Junction Temperature
- Fast recovery time for switching
- High Forward Surge Capability
- Lead free in compliance with EU RoHS 2011/65/EU directive

Mechanical Data

- Circuit figure: Single positive
- Leads: Solderable per mil-std-202, Method 208
- Polarity: as marked
- Mounting torque: 5 in-lbs maximum
- Terminals: Puretin plated
- Weight: TO-220AC 1.80 grams

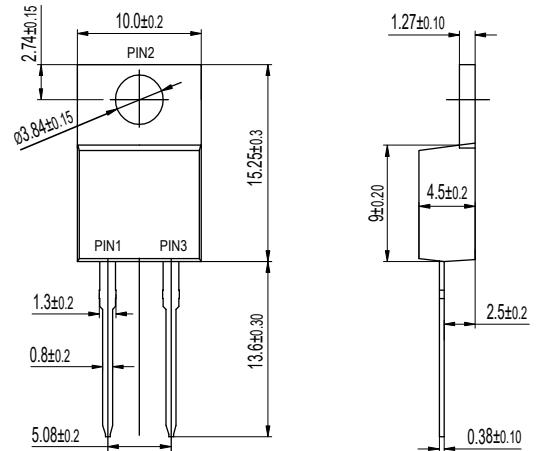

TO-220AC

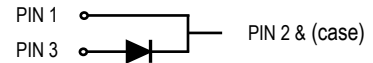

Maximum Ratings And Electrical Characteristics $T_A = 25^\circ\text{C}$

RATINGS	SYMBOL	FR 1001	FR 1002	FR 1004	FR 1006	FR 1008	FR 1010	UNIT
Maximum repetitive reverse voltage	V_{RRM}	100	200	400	600	800	1000	V
Maximum RMS voltage	V_{RMS}	70	140	280	420	560	700	V
Maximum DC blocking voltage	VDC	100	200	400	600	800	1000	V
Maximum average forward current	I_{AV}	10						A
Peak forward surge current, 8.3ms single half sine-wave superimposed on rated load	I_{FSM}	120						A
Typical thermal resistance per diode (Note 1)	$R_{\theta-JC}$	2.5						$^\circ\text{C/W}$
Operating junction temperature range	T_J	-55 to +150						$^\circ\text{C}$
Storage temperature range	T_{STG}	-55 to +150						$^\circ\text{C}$
Maximum forward voltage per leg at 10A	V_F	1.30						V
Maximum average reverse current at rated DC blocking voltage $T_J=25^\circ\text{C}$ $T_J=125^\circ\text{C}$	I_R	10 250						μA
Maximum reverse recovery time (Note 2)	T_{RR}	150		250		500		nS

Notes: 1. Thermal resistance from junction to case.
2. Test conditions: $I_F=0.5\text{A}$, $I_R=1.0\text{A}$, $I_{RR}=0.25\text{A}$.

FIG. 1 - TYPICAL FORWARD CURRENT DERATING CURVE

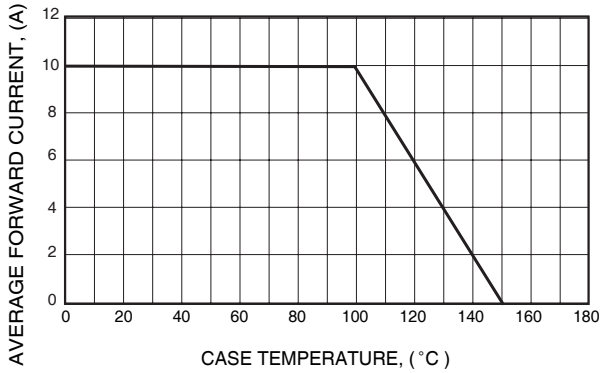

FIG. 3 - MAXIMUM NON-REPETITIVE FORWARD SURGE CURRENT

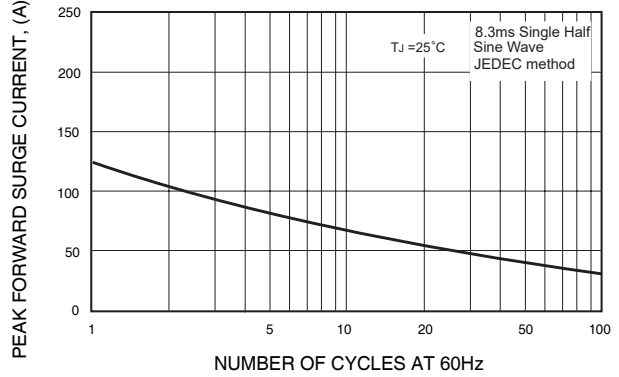

FIG. 4 - TYPICAL REVERSE CHARACTERISTICS

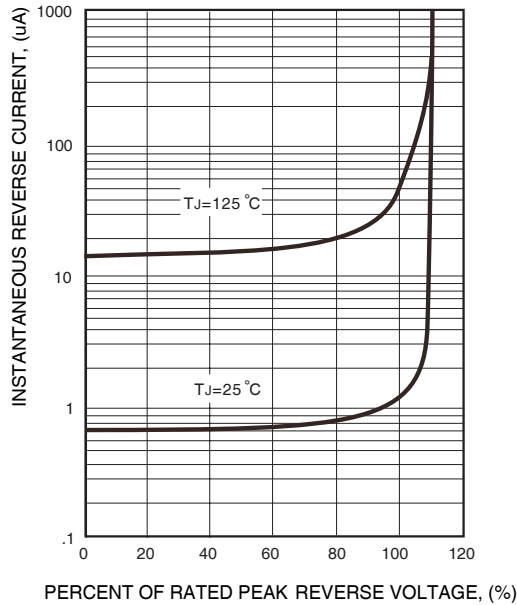

FIG. 2 - TYPICAL INSTANTANEOUS FORWARD CHARACTERISTICS

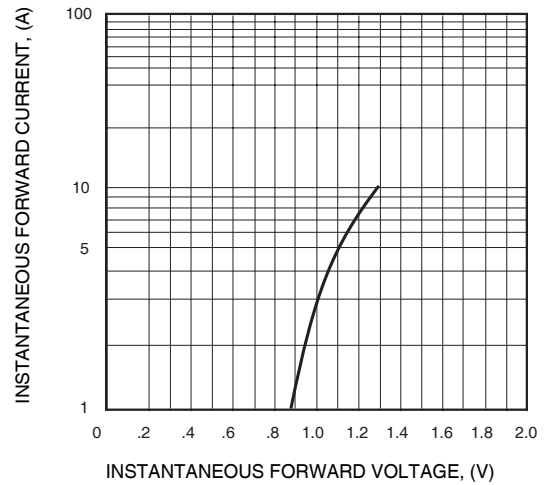
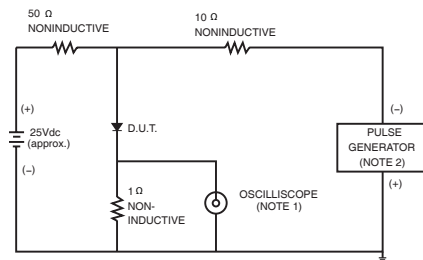

FIG.6- TEST CIRCUIT DIAGRAM AND REVERSE RECOVERY TIME CHARACTERISTICS



NOTES: 1. Rise Time= 7ns max., Input Impedance= 1 megohm, 22pF.
2. Rise Time= 10ns max., Source Impedance= 50 ohms.

