

VOLTAGE RANGE: 100 - 1000V

CURRENT: 16A

Features

- Glass passivated chip junctions
- Low reverse current operation
- High Junction Temperature
- Fast recovery time for switching
- High Forward Surge Capability
- Lead free in compliance with EU RoHS 2011/65/EU directive

Mechanical Data

- Circuit figure: Single positive
- Leads: Solderable per mil-std-202, Method 208
- Polarity: as marked
- Mounting torque: 5 in-lbs maximum
- Terminals: Puretin plated
- Weight: TO-220AC 1.85 grams

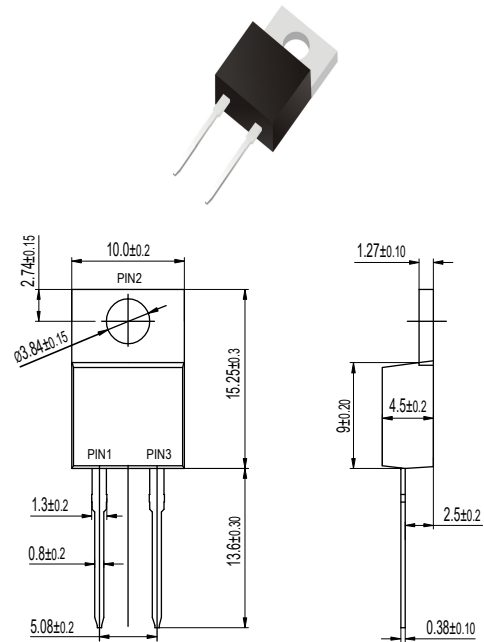

TO-220AC

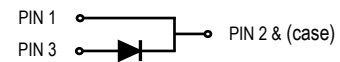

Maximum Ratings And Electrical Characteristics $T_A = 25^\circ\text{C}$

RATINGS	SYMBOL	FR 1601	FR 1602	FR 1604	FR 1606	FR 1608	FR 1610	UNIT
Maximum repetitive reverse voltage	VRRM	100	200	400	600	800	1000	V
Maximum RMS voltage	VRMS	70	140	280	420	560	700	V
Maximum DC blocking voltage	VDC	100	200	400	600	800	1000	V
Maximum average forward current	I _{AV}	16						A
Peak forward surge current, 8.3ms single half sine-wave superimposed on rated load	I _{FSM}	200						A
Typical thermal resistance per diode (Note 1)	R _{θ-JC}	2.5						°C/W
Operating junction temperature range	T _J	-55 to +150						°C
Storage temperature range	T _{STG}	-55 to +150						°C
Maximum forward voltage per leg at 16A	V _F	1.30						V
Maximum average reverse current at rated DC blocking voltage	I _R	10 250						μA
Maximum reverse recovery time (Note 2)	T _{RR}	150		250		500		nS

Notes: 1. Thermal resistance from junction to case.
2. Test conditions: I_F=0.5A I_R=1.0A RR=0.25A.

FIG. 1 - TYPICAL FORWARD CURRENT DERATING CURVE

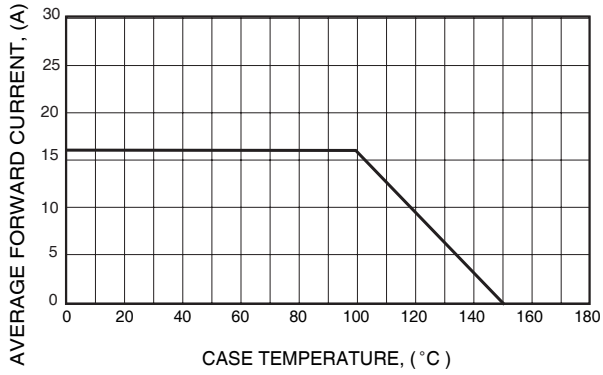

FIG. 3 - MAXIMUM NON-REPETITIVE FORWARD SURGE CURRENT

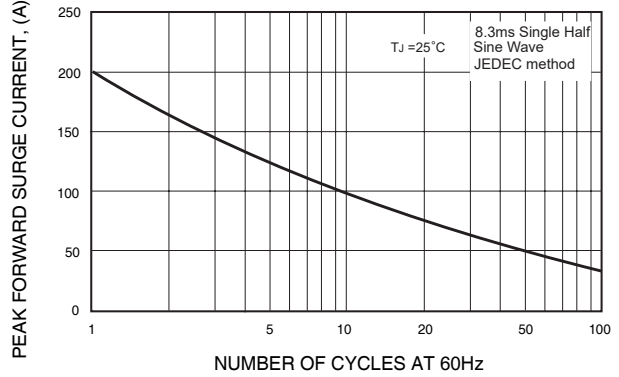

FIG. 4 - TYPICAL REVERSE CHARACTERISTICS

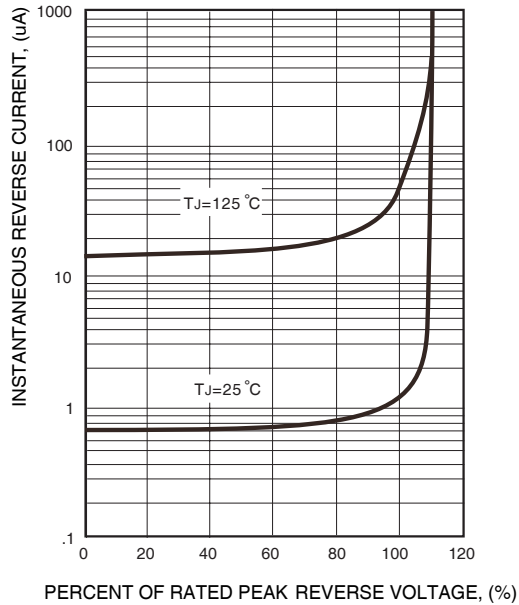

FIG. 2 - TYPICAL INSTANTANEOUS FORWARD CHARACTERISTICS

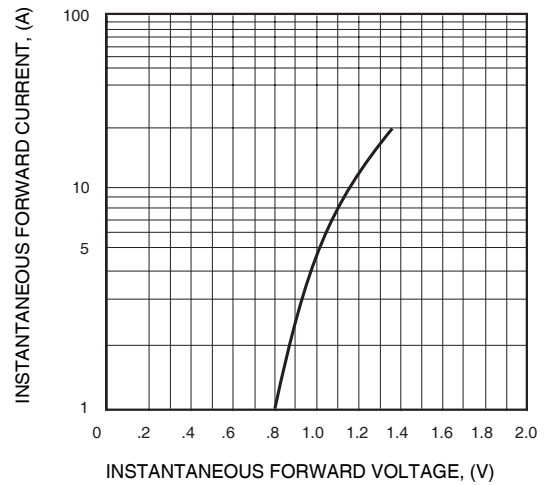
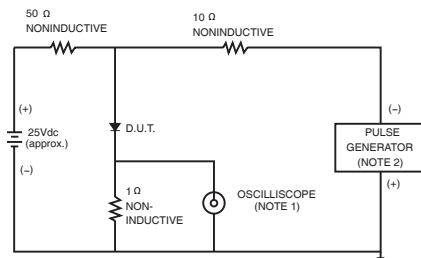

FIG.6- TEST CIRCUIT DIAGRAM AND REVERSE RECOVERY TIME CHARACTERISTICS



NOTES: 1. Rise Time= 7ns max., Input Impedance= 1 megohm, 22pF.
2. Rise Time= 10ns max., Source Impedance= 50 ohms.

