

VOLTAGE RANGE: 100 - 800V

CURRENT: 10A

Features

- Glass passivated chip junctions
- Super fast recovery time for switching mode application
- High Forward Surge Capability
- Low Reverse Current
- Lead free in compliance with EU RoHS 2011/65/EU directive

Mechanical Data

- Circuit figure: Single positive
- Leads: Solderable per mil-std-202, Method 208
- Polarity: as marked
- Mounting torque: 5 in-lbs maximum
- Terminals: Puretin plated
- Weight: ITO-220AC 1.65 grams

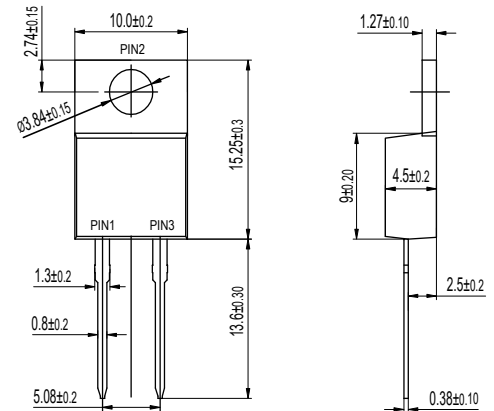
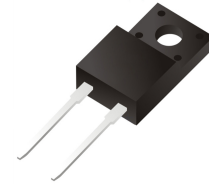

ITO-220AC

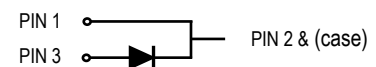

Maximum Ratings And Electrical Characteristics $T_A = 25^\circ\text{C}$

RATINGS	SYMBOL	SFF 1002	SFF 1003	SFF 1004	SFF 1005	SFF 1006	SFF 1007	SFF 1008	UNIT
Maximum repetitive reverse voltage	V_{RRM}	200	300	400	500	600	700	800	V
Maximum RMS voltage	V_{RMS}	140	210	280	350	420	490	560	V
Maximum DC blocking voltage	V_{DC}	200	300	400	500	600	700	800	V
Maximum average forward current	I_{AV}	10							A
Peak forward surge current, 8.3ms single half sine-wave superimposed on rated load	I_{FSM}	150							A
Typical thermal resistance per diode (Note 1)	$R_{\theta-JC}$	4.0							$^\circ\text{C}/\text{W}$
Operating junction temperature range	T_J	-55 to +150							$^\circ\text{C}$
Storage temperature range	T_{STG}	-55 to +150							$^\circ\text{C}$
Typical forward voltage per leg at 10A	V_F	1.00	1.30	1.70		2.80		V	
Maximum average reverse current at rated DC blocking voltage $T_J=25^\circ\text{C}$ $T_J=125^\circ\text{C}$	I_R	5 250							μA
Typical reverse recovery time (Note 2)	T_{RR}	35							nS

Notes: 1. Thermal resistance from junction to case.
2. Test conditions: $I_F=0.5\text{A}$, $I_R=1.0\text{A}$, $I_{RR}=0.25\text{A}$.

FIG. 1 - TYPICAL FORWARD CURRENT DERATING CURVE

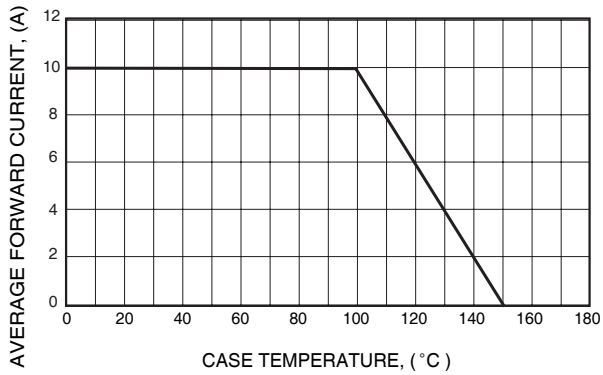

FIG. 3 - MAXIMUM NON-REPETITIVE FORWARD SURGE CURRENT

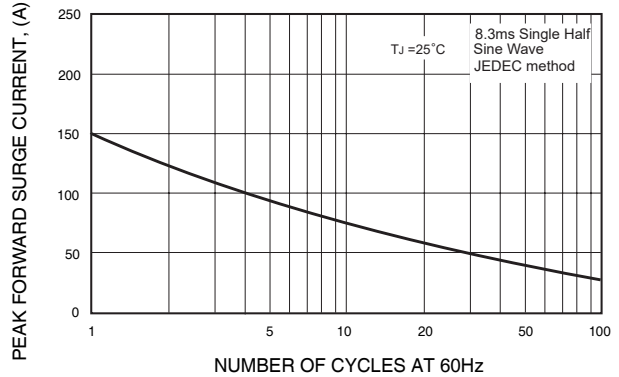

FIG. 4 - TYPICAL REVERSE CHARACTERISTICS

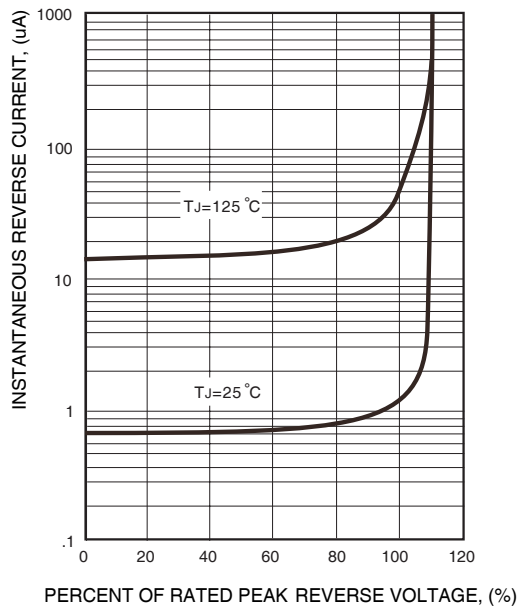

FIG. 2 - TYPICAL INSTANTANEOUS FORWARD CHARACTERISTICS

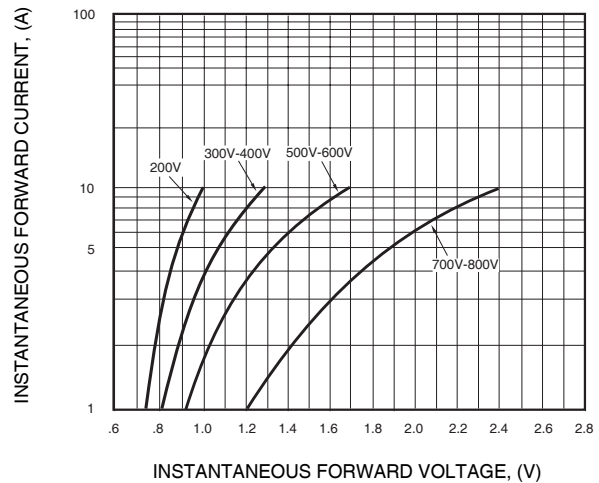
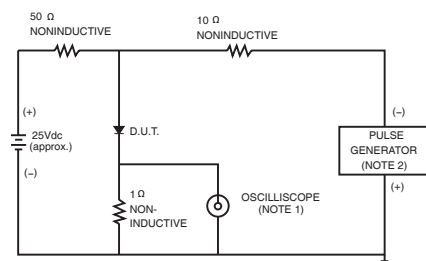

FIG.6- TEST CIRCUIT DIAGRAM AND REVERSE RECOVERY TIME CHARACTERISTICS



NOTES: 1. Rise Time= 7ns max., Input Impedance= 1 megohm, 22pF.
 2. Rise Time= 10ns max., Source Impedance= 50 ohms.

