

1. Scope

This specification is applies to Multilayer Ceramic Chip Capacitor (MLCC) for use in electric equipment for the voltage is ranging from 100V to 5KV.

The MLCC support for Lead-Free wave and reflow soldering, and electrical characteristic and reliability are same as before. **(This product compliant with the RoHS.)**

2. Parts Number Code

C	1206	N	560	J	102	T
---	------	---	-----	---	-----	---

(1) (2) (3) (4) (5) (6) (7)

(1)Product

Product Code	
C	Multilayer Ceramic Chip Capacitor

(2)Chip Size

Code	Length×Width	unit : mm(inch)
0201	0.60× 0.30	(.024× .011)
0402	1.00× 0.50	(.039× .020)
0603	1.60× 0.80	(.063× .031)
0805	2.00× 1.25	(.079× .049)
1206	3.20× 1.60	(.126× .063)
1210	3.20× 2.50	(.126× .098)
1808	4.60× 2.00	(.181× .079)
1812	4.60× 3.20	(.181× .125)
1825	4.60× 6.35	(.181× .250)
2208	5.70× 2.00	(.220× .197)
2211	5.70× 2.80	(.220× .110)
2220	5.70× 5.00	(.220× .197)
2225	5.70× 6.35	(.220× .250)

(3)Temperature Characteristics

Code	Temperature Characteristic	Temperature Range	Temperature Coefficient
N	NPO	-55℃~+125℃	30 ppm/℃
L	SL	-30℃~+85℃	+350~-1000ppm
X	X7R	-55℃~+125℃	± 15%
B	X5R	-55℃~+85℃	± 15%
S	X6S	-55℃~+105℃	± 22%
Y	Y5V	-30℃~+85℃	+22/-82%
Z	Z5U	+10℃~+85℃	+22/-56%
E	Y5U	-30℃~+85℃	+22/-56%

(4)Capacitance

unit :pico farads(pF)

Code	Nominal Capacitance (pF)
5R0	5.0
560	56.0
221	220.0
222	2,200.0
223	22,000.0
474	470,000.0
105	1,000,000.0
106	10,000,000.0

(5)Capacitance Tolerance

Code	Tolerance	Nominal Capacitance
B	± 0.10 pF	Less Than 10 pF (Include 10 pF)
C	± 0.25 pF	
D	± 0.50 pF	More Than 10 pF
F	± 1.00 pF	
F	± 1.00 %	
G	± 2.00 %	
J	± 5.00 %	
K	± 10.0 %	
M	± 20.0 %	
Z	+80/-20 %	

(6)Rated Voltage

Code	Rated Voltage (Vdc)
101	100
201	200
251	250
501	500
631	630
102	1,000
202	2,000
252	2,500
302	3,000
502	5,000

(7)Tapping

Code	Type
T	Tape & Reel
B	Bulk

※ If there is a decimal point, it shall be expressed by an English capital letter R

3. Nominal Capacitance and Tolerance
3.1 Standard Combination of Nominal Capacitance and Tolerance

Class	Characteristic	Tolerance		Nominal Capacitance
I	NPO / SL	Less Than 10 pF	B (± 0.10 pF)	0.5,1,1.5,2,2.5,3
			C (± 0.25 pF)	0.5,1,1.5,2,2.5,3,3.5,4,4.5,5
			D (± 0.50 pF)	5,6,7,8,9,10
			F (± 1.00 pF)	6,7,8,9,10
		More Than 10 pF	F (± 1.00 %)	E-12, E-24 series
			G (± 2.00 %)	
			J (± 5.00 %)	
K (± 10.0 %)				
II	X7R/X5R/X7E	K (± 10.0 %), M (± 20.0 %)		E-3, E-6 series
	Y5V	M (± 20.0 %), Z (+80/-20 %)		E-3 series
	Z5U			
	Y5U			

3.2 E series(standard Number)

Standard No.	Application Capacitance											
E-3	1.0				2.2				4.7			
E-6	1.0		1.5		2.2		3.3		4.7		6.8	
E-12	1.0	1.2	1.5	1.8	2.2	2.7	3.3	3.9	4.7	5.6	6.8	8.2
E-24	1.0	1.2	1.5	1.8	2.2	2.7	3.3	3.9	4.7	5.6	6.8	8.2
	1.1	1.3	1.6	2.0	2.4	3.0	3.6	4.3	5.1	6.2	7.5	9.1

4. Operation Temperature Range

Class	Characteristic	Temperature Range	Reference Temp.
I	NPO	-55°C ~ +125°C	25°C
	SL	-25°C ~ +125°C	25°C
II	X7R	-55°C ~ +125°C	25°C
	X5R	-55°C ~ +85°C	25°C
	X6S	-55°C ~ +105°C	25°C
	Y5V	-30°C ~ +85°C	25°C
	Z5U	+10°C ~ +85°C	25°C
	Y5U	-30°C ~ +85°C	25°C
Other		-25°C ~ +85°C	25°C

5. Storage Condition

Storage Temperature : 5 to 40°C

Relative Humidity : 20 to 70 %

Storage Time : 6 months max.

6. Dimensions

6.1 Configuration and Dimension :

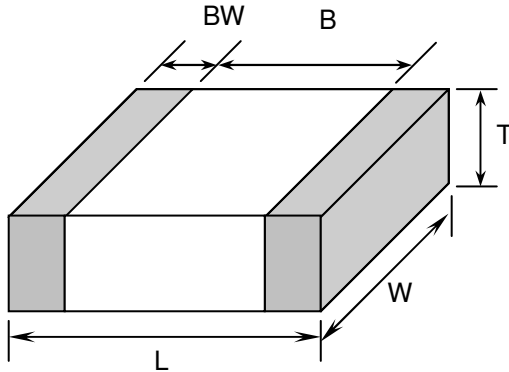

Unit:mm					
TYPE	L	W	T	B (min)	BW (min)
1206	3.20± 0.30	1.60± 0.20	1.25± 0.15	1.50	0.30

6.2 Termination Type :

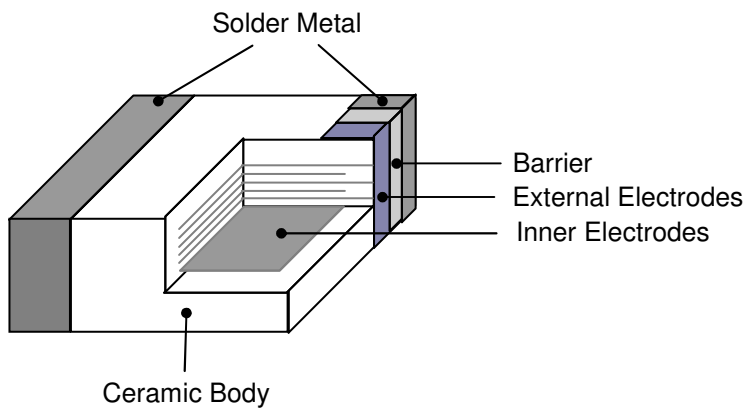

7. Performance

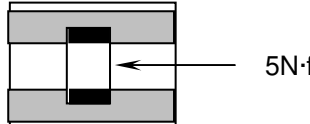
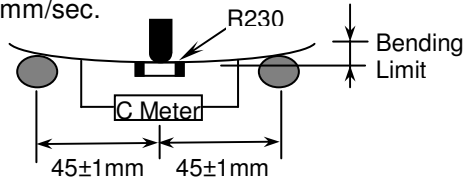
No.	Item		Specification			Test Condition									
1	Visual		No abnormal exterior appearance			Visual inspection									
2	Dimension		See Page 3			Visual inspection									
3	Insulation Resistance		10,000MΩ or 500/CΩ Product Whichever Is Smaller			V ≤ 500V, Rated Voltage V > 500V, Applied 500Vdc Charge Time : 60sec. Is applied less than 50mA current.									
4	Capacitance	Class I NPO/SL	Within The Specified Tolerance			Class I : NPO/SL <table border="1"> <thead> <tr> <th>Capacitance</th> <th>Frequency</th> <th>Voltage</th> </tr> </thead> <tbody> <tr> <td>C ≤ 100pF</td> <td>1MHz±10%</td> <td>1.0±0.2Vrms</td> </tr> <tr> <td>C > 100pF</td> <td>1KHz±10%</td> <td></td> </tr> </tbody> </table>	Capacitance	Frequency	Voltage	C ≤ 100pF	1MHz±10%	1.0±0.2Vrms	C > 100pF	1KHz±10%	
		Capacitance	Frequency	Voltage											
C ≤ 100pF	1MHz±10%	1.0±0.2Vrms													
C > 100pF	1KHz±10%														
Class II	Within The Specified Tolerance			Class II : <table border="1"> <thead> <tr> <th colspan="2">Frequency</th> <th>Voltage</th> </tr> </thead> <tbody> <tr> <td>X7R</td> <td>1KHz±10%</td> <td>1.0±0.2Vrms</td> </tr> <tr> <td>Z5U/Y5U</td> <td>1KHz±10%</td> <td>1.0±0.2Vrms</td> </tr> </tbody> </table> Perform a heat temperature at 150±5°C for 30min. then place room temp. for 24±2hr.	Frequency		Voltage	X7R	1KHz±10%	1.0±0.2Vrms	Z5U/Y5U	1KHz±10%	1.0±0.2Vrms		
Frequency		Voltage													
X7R	1KHz±10%	1.0±0.2Vrms													
Z5U/Y5U	1KHz±10%	1.0±0.2Vrms													
5	Q	Class I NPO/SL	More Than 30pF : Q ≥ 1000 30pF & Below: Q ≥ 400 + 20C (C : Capacitance , pF)			<table border="1"> <thead> <tr> <th colspan="2">Frequency</th> <th>Voltage</th> </tr> </thead> <tbody> <tr> <td>X7R</td> <td>1KHz±10%</td> <td>1.0±0.2Vrms</td> </tr> <tr> <td>Z5U/Y5U</td> <td>1KHz±10%</td> <td>1.0±0.2Vrms</td> </tr> </tbody> </table> Perform a heat temperature at 150±5°C for 30min. then place room temp. for 24±2hr.	Frequency		Voltage	X7R	1KHz±10%	1.0±0.2Vrms	Z5U/Y5U	1KHz±10%	1.0±0.2Vrms
			Frequency		Voltage										
	X7R	1KHz±10%	1.0±0.2Vrms												
Z5U/Y5U	1KHz±10%	1.0±0.2Vrms													
Tan δ	Class II	Char.	Maximum												
		X7R	2.5%												
		Z5U/Y5U	4.0%												
6	Withstanding Voltage		No dielectric breakdown or mechanical breakdown			V < 500V : 200% Rated Voltage 500V ≤ V < 1000V: 150% Rated Voltage 1000 ≤ V : 120% Rated Voltage for 1~5 sec. Current is limited to less than 50mA. ※ Withstanding voltage testing requires immersion of the element in a isolation fluid prevent arcing on the chip surface, at voltage over 1000Vdc.									
7	Temperature Capacitance Coefficient	Class I	Char.	Temp. Range	Cap. Change(%)	Class I : [C2-C1/C1(T2-T1)] × 100% Class II : (C2-C1)/C1 × 100% T1: Standard temperature (25°C) T2: Test temperature C1:Capacitance at standard temperature(25°C) C2: Capacitance at test temperature (T2)									
			NPO	-55°C ~ +125°C	± 30 ppm/°C										
			SL	-30°C ~ +85°C	+350~-1000ppm										
		Class II	Char.	Temp. Range	Cap. Change(%)										
			X7R	-55°C ~ +125°C	± 15%										
Y5U	-30°C ~ +85°C	+22% ~ -56%													
Z5U	+10°C ~ +85°C	+22% ~ -56%													
8	Adhesive Strength of Termination		No indication of peeling shall occur on the terminal electrode.			A 5N·f (≅ 0.5Kg·f) pull force shall be applied for 10± 1 second. 									
9	Resistance to Flexure of Substrate	Appearance	No mechanical damage shall be occur.			Bending shall be applied to the 1.0 mm with 1.0 mm/sec. 									
		C-Meter	Capacitance Change												
	Char.		Cap. Change												
	NPO		≤ ± 5.0%												
	SL		≤ ± 5.0%												
X7R	≤ ± 12.5%														
Y5U/Z5U	≤ ± 30.0%														

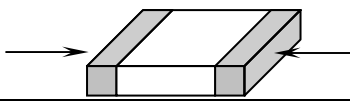
No.	Item	Specification	Test Condition															
10	Solderability	<p>More than 90% of the terminal surface is to be soldered newly, so metal part does not come out or dissolve .</p> 	<p>Solder Temperature : 245± 5°C Dip Time : 5 ± 0.5 sec. Immersing Speed : 25±10% mm/s Solder : H63A Flux : Rosin Preheat : At 80~120 °C for 10~30sec.</p>															
11	Resistance To Soldering Heat	Appearance	No mechanical damage shall occur.															
		Capacitance	Characteristic	Cap. Change														
			Class I (NPO/SL)	Within ± 2.5% or ±0.25pF whichever is larger of initial value														
			Class II	<table border="1"> <tr> <td>X7R</td> <td>Within ± 10%</td> </tr> <tr> <td>Z5U/Y5U</td> <td>Within ± 20%</td> </tr> </table>	X7R	Within ± 10%	Z5U/Y5U	Within ± 20%										
		X7R	Within ± 10%															
		Z5U/Y5U	Within ± 20%															
		Q Class I	To satisfy the specified initial value															
Tan δ Class II	To satisfy the specified initial value																	
Insulation Resistance	To satisfy the specified initial value																	
Withstand Voltage	To satisfy the specified initial value																	
			<p>Class II capacitor shall be set for 48±4 hours at room temperature after one hour heat treatment at 150 +0/-10°C before initial measure.</p> <p>Preheat : At 150± 10°C For 60~120sec. Dip : Solder Temperature of 260± 5°C Dip Time : 10 ± 1sec. Immersing Speed : 25±10% mm/s Solder : H63A Flux : Rosin</p> <p>Measure at room temperature after cooling for Class I : 24 ± 2 Hours Class II : 48 ± 4 Hours</p>															
12	Temperature Cycle	Appearance	No mechanical damage shall occur															
		Capacitance	Characteristic	Cap. Change														
			Class I (NPO/SL)	Within ± 2.5% or ±0.25pF whichever is larger of initial value														
			Class II	<table border="1"> <tr> <td>X7R</td> <td>Within ± 7.5%</td> </tr> <tr> <td>Z5U/Y5U</td> <td>Within ± 20%</td> </tr> </table>	X7R	Within ± 7.5%	Z5U/Y5U	Within ± 20%										
		X7R	Within ± 7.5%															
		Z5U/Y5U	Within ± 20%															
		Q Class I	To satisfy the specified initial value															
Tan δ Class II	To satisfy the specified initial value																	
Insulation Resistance	To satisfy the specified initial value																	
			<p>Class II capacitor shall be set for 48± 4 hours at room temperature after one hour heat treatment at 150 +0/-10 °C before initial measure.</p> <p>Capacitor shall be subjected to five cycles of the temperature cycle as following:</p> <table border="1"> <thead> <tr> <th>Step</th> <th>Temp.(°C)</th> <th>Time(min)</th> </tr> </thead> <tbody> <tr> <td>1</td> <td>Min Rated Temp. +0/-3</td> <td>30</td> </tr> <tr> <td>2</td> <td>25</td> <td>3</td> </tr> <tr> <td>3</td> <td>Max Rated Temp. +3/-0</td> <td>30</td> </tr> <tr> <td>4</td> <td>25</td> <td>3</td> </tr> </tbody> </table> <p>Measure at room temperature after cooling for Class I :24 ± 2 Hrs Class II :48 ± 4 Hrs Solder the capacitor on P.C. board shown in Fig 2. before testing.</p>	Step	Temp.(°C)	Time(min)	1	Min Rated Temp. +0/-3	30	2	25	3	3	Max Rated Temp. +3/-0	30	4	25	3
Step	Temp.(°C)	Time(min)																
1	Min Rated Temp. +0/-3	30																
2	25	3																
3	Max Rated Temp. +3/-0	30																
4	25	3																
13	Humidity	Appearance	No mechanical damage shall occur															
		Capacitance	Characteristic	Cap. Change														
			Class I (NPO/SL)	Within ± 5.0% or ±0.5pF whichever is larger of initial value														
			Class II	<table border="1"> <tr> <td>X7R</td> <td>Within ± 15%</td> </tr> <tr> <td>Z5U/Y5U</td> <td>Within ± 30%</td> </tr> </table>	X7R	Within ± 15%	Z5U/Y5U	Within ± 30%										
		X7R	Within ± 15%															
		Z5U/Y5U	Within ± 30%															
		Q Class I	More Than 30pF : Q ≥ 350 30pF & Below: Q ≥ 275 + 2.5×C															
Tan δ Class II	Char.	Maximum																
	X7R	5.0%																
Insulation Resistance	Z5U/Y5U	5.0%																
	1,000MΩ or 50/C Ω whichever is smaller.																	
			<p>Class II capacitor shall be set for 48± 4 hours at room temperature after one hour heat treatment at 150+0/-10 °C before initial measure.</p> <p>Temperature : 40± 2°C Relative Humidity : 90 ~ 95%RH Test Time : 500 + 12/ -0Hr</p> <p>Measure at room temperature after cooling for Class I : 24 ± 2Hrs Class II : 48 ± 4Hrs</p> <p>Solder the capacitor on P.C. board shown in Fig 2. before testing.</p>															

No.	Item	Specification	Test Condition									
14	High Temperat. Load	Appearance	No mechanical damage shall occur	Class II capacitors applied DC voltage (following table) is applied for one hour at maximum operation temperature $\pm 3^{\circ}\text{C}$ then shall be set for 48 ± 4 hours at room temperature and the initial measurement shall be conducted. Applied Voltage : <table border="1" style="margin: 10px auto; border-collapse: collapse;"> <thead> <tr style="background-color: #b0c4de;"> <th style="width: 50%;">Rated Voltage</th> <th style="width: 50%;">Applied Voltage</th> </tr> </thead> <tbody> <tr> <td>$V \leq 250\text{Vdc}$</td> <td>150% Rated Voltage</td> </tr> <tr> <td>Less Than 1KVdc</td> <td>120% Rated Voltage</td> </tr> <tr> <td>More Than 1KVdc(include 1KV)</td> <td>100% Rated Voltage</td> </tr> </tbody> </table>	Rated Voltage	Applied Voltage	$V \leq 250\text{Vdc}$	150% Rated Voltage	Less Than 1KVdc	120% Rated Voltage	More Than 1KVdc(include 1KV)	100% Rated Voltage
		Rated Voltage	Applied Voltage									
		$V \leq 250\text{Vdc}$	150% Rated Voltage									
		Less Than 1KVdc	120% Rated Voltage									
		More Than 1KVdc(include 1KV)	100% Rated Voltage									
		Capacitance	Characteristic		Cap. Change							
			Class I (NPO/SL)		Within $\pm 3.0\%$ or $\pm 0.3\text{pF}$ whichever is larger							
Class II	<table style="width: 100%; border-collapse: collapse;"> <tr> <td style="width: 50%; text-align: center;">X7R</td> <td style="width: 50%; text-align: center;">Within $\pm 15\%$</td> </tr> <tr> <td style="text-align: center;">Z5U/Y5U</td> <td style="text-align: center;">Within $\pm 30\%$</td> </tr> </table>		X7R	Within $\pm 15\%$	Z5U/Y5U	Within $\pm 30\%$						
X7R	Within $\pm 15\%$											
Z5U/Y5U	Within $\pm 30\%$											
Q	More Than 30pF : $Q \geq 350$ 30pF & Below: $Q \geq 275 + 2.5 \times C$											
Tan δ	Char.	maximum										
Class II	<table style="width: 100%; border-collapse: collapse;"> <tr> <td style="width: 50%; text-align: center;">X7R</td> <td style="width: 50%; text-align: center;">5.0%</td> </tr> <tr> <td style="text-align: center;">Z5U/Y5U</td> <td style="text-align: center;">5.0%</td> </tr> </table>	X7R	5.0%	Z5U/Y5U	5.0%	5.0%						
X7R	5.0%											
Z5U/Y5U	5.0%											
Insulation Resistance	1,000M Ω or 50/C Ω whichever is smaller. (C in Farad)											
15	Vibration	Appearance	No mechanical damage shall occur	Solder the capacitor on P.C. Board shown in Fig 2. before testing. Vibrate the capacitor with amplitude of 1.5mm P-P changing the frequencies from 10Hz to 55Hz and back to 10Hz in about 1 min. Repeat this for 2 hours each in 3perpendicular directions.								
		Capacitance	Characteristic		Cap. Change							
			Class I (NPO/SL)		Within $\pm 2.5\%$ or $\pm 0.25\text{pF}$ whichever is larger							
			Class II		<table style="width: 100%; border-collapse: collapse;"> <tr> <td style="width: 50%; text-align: center;">X7R</td> <td style="width: 50%; text-align: center;">Within $\pm 7.5\%$</td> </tr> <tr> <td style="text-align: center;">Z5U/Y5U</td> <td style="text-align: center;">Within $\pm 20\%$</td> </tr> </table>	X7R	Within $\pm 7.5\%$	Z5U/Y5U	Within $\pm 20\%$			
		X7R	Within $\pm 7.5\%$									
		Z5U/Y5U	Within $\pm 20\%$									
		Q	To satisfy the specified initial value									
Tan δ	To satisfy the specified initial value											
Class II	To satisfy the specified initial value											
Insulation Resistance	To satisfy the specified initial value											

Fig.1
P.C. Board for Bending Strength Test

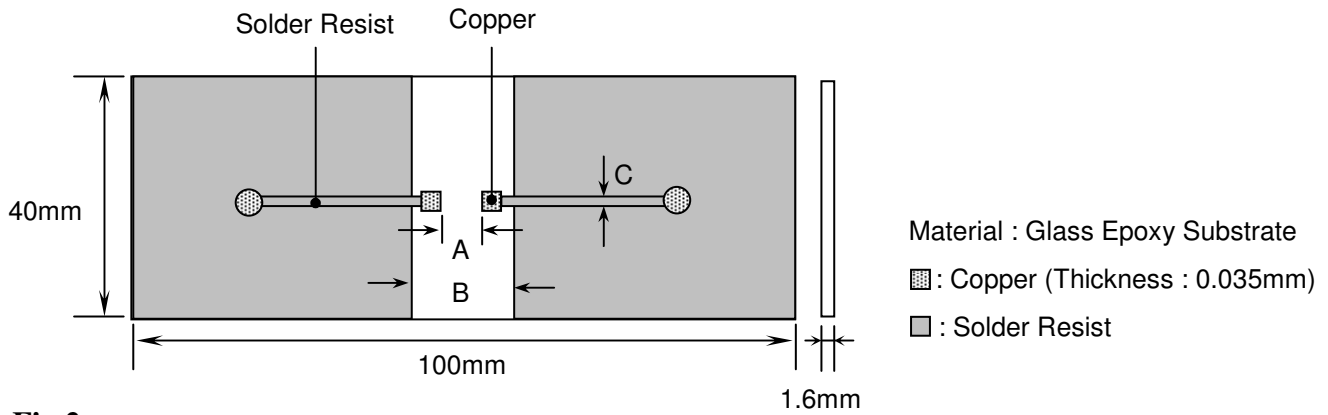
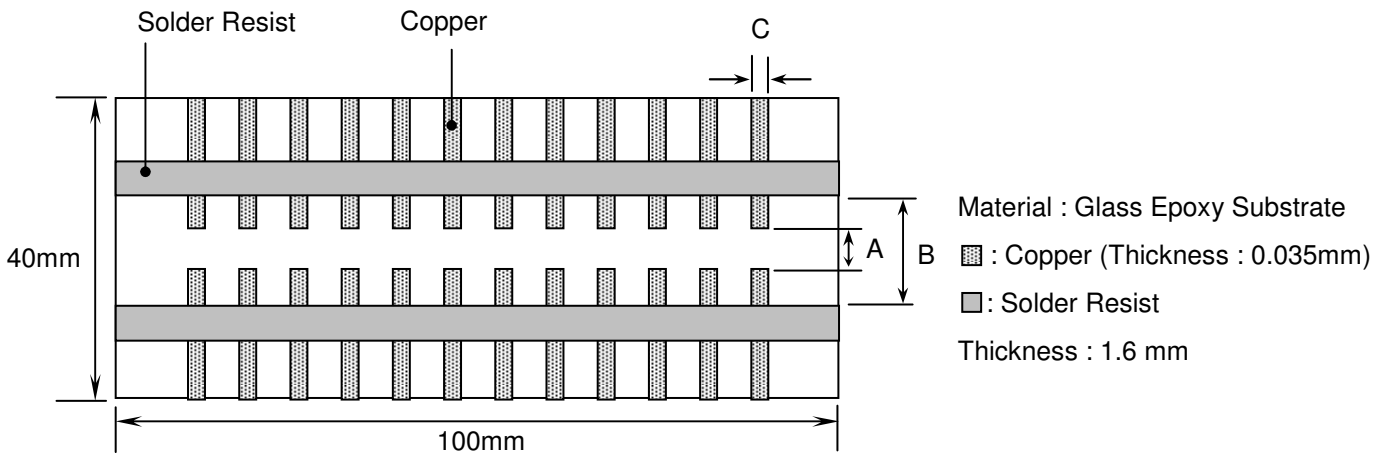

Fig.2
Test Substrate



Unit:mm

Type	A	B	C
0201	0.2	0.9	0.4
0402	0.5	1.5	0.6
0603	1.0	3.0	1.0
0805	1.2	4.0	1.6
1206	2.2	5.0	2.0
1210	2.2	5.0	2.9
1808	3.5	7.0	2.5
1812	3.5	7.0	3.7
2208	4.5	8.0	2.5
2211	4.5	8.0	3.0
2220	4.5	8.0	5.6

8. Packing
8.1 Bulk Packing

According to customer request.

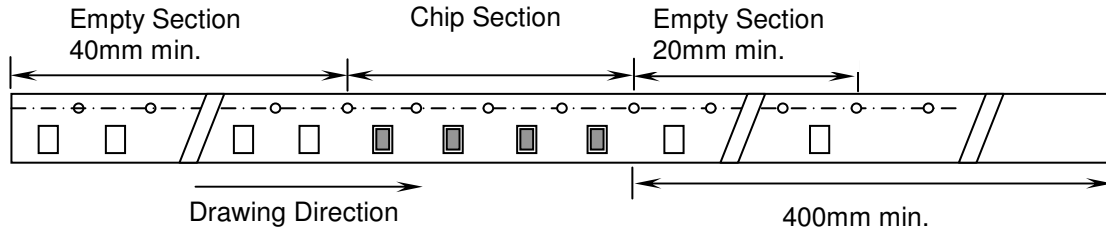
8.2 Chip Capacitors Tape Packing

8.3 Material And Quantity

Tape	0201	0402	0603/0805	
Material	$T \leq 0.33\text{mm}$	$T \leq 0.55\text{mm}$	$T \leq 0.90\text{mm}$	$T > 0.90\text{mm}$
Paper	15,000 pcs/Reel	10,000 pcs/Reel	4,000 pcs/Reel	NA
Plastic	NA	NA	NA	3,000 pcs/Reel

Tape	1206			1210/1808	
Material	$T \leq 0.90\text{mm}$	$0.90\text{mm} < T \leq 1.25\text{mm}$	$T > 1.25\text{mm}$	$T \leq 1.25\text{mm}$	$T > 1.25\text{mm}$
Paper	4,000 pcs/Reel	NA	NA	NA	NA
Plastic	NA	3,000 pcs/Reel	2,000 pcs/Reel	3000 pcs/Reel	2000 pcs/Reel

Tape	1812/1825/2211/2220		2225		2208
Material	$T \leq 2.20\text{mm}$	$T > 2.20\text{mm}$	$T \leq 2.20\text{mm}$	$T > 2.20\text{mm}$	$T \leq 2.20\text{mm}$
Paper	NA	NA	NA	NA	NA
Plastic	1000 pcs/Reel	700 pcs/Reel	1000 pcs/Reel	400 pcs/Reel	1000 pcs/Reel

NA : Not Available

8.4 Cover Tape Reel Off Force
9.4.1 Peel-Off Force

$$5 \text{ g}\cdot\text{f} \leq \text{Peel-Off Force} \leq 70 \text{ g}\cdot\text{f}$$

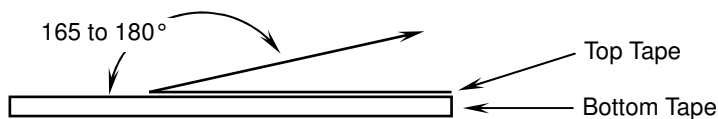
9.4.2 Measure Method

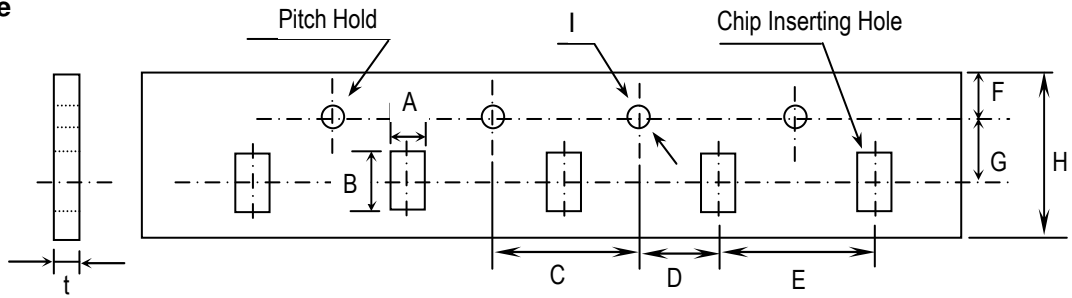
8.5 Paper Tape

Unit:mm

TYPE	A	B	C	D	E
0201	0.37± 0.1	0.67± 0.1	4.00± 0.1	2.00± 0.05	2.00± 0.1
0402	0.61± 0.1	1.20± 0.1			4.00± 0.1
0603	1.10± 0.2	1.90± 0.2			
0805	1.50± 0.2	2.30± 0.2			
1206	1.90± 0.2	3.50± 0.2			
1210	2.90± 0.2	3.60± 0.2			

TYPE	F	G	H	I	t
0201	1.75± 0.10	3.50± 0.05	8.0± 0.30	φ 1.50 +0.10/-0	1.10 max.
0402					
0603					
0805					
1206					
1210					

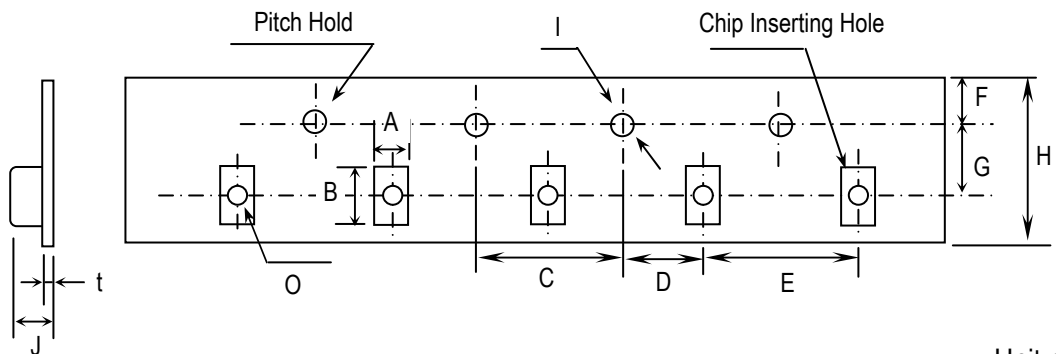
8.6 Plastic Tape

Unit:mm

Type	A	B	C	D	E	F
0805	1.5±0.2	2.3±0.2	4.0± 0.1	2.0± 0.05	4.0± 0.1	1.75± 0.1
1206	1.9±0.2	3.5±0.2				
1210	2.9±0.2	3.6±0.2				
1808	2.5±0.2	4.9±0.2				
1812	3.6±0.2	4.9±0.2				
1825	6.9±0.2	4.9±0.2	8.0± 0.1			
2208	2.5±0.2	6.1±0.2				
2211	3.2±0.2	6.1±0.2				
2220	5.4±0.2	6.1±0.2				
2225	6.9±0.2	6.1±0.2				

Type	G	H	I	J	t	O
0805	3.5± 0.05	8.0± 0.3	φ 1.5+0.1/-0	3.0 max.	0.3 max.	0.15 min.
1206						
1210						
1808	5.5± 0.05	12.0 ± 0.3		4.0 max.		
1812						
1825						
2208						
2211						
2220						
2225						

8.7 Reel Dimensions

Reel Material : Polystyrene

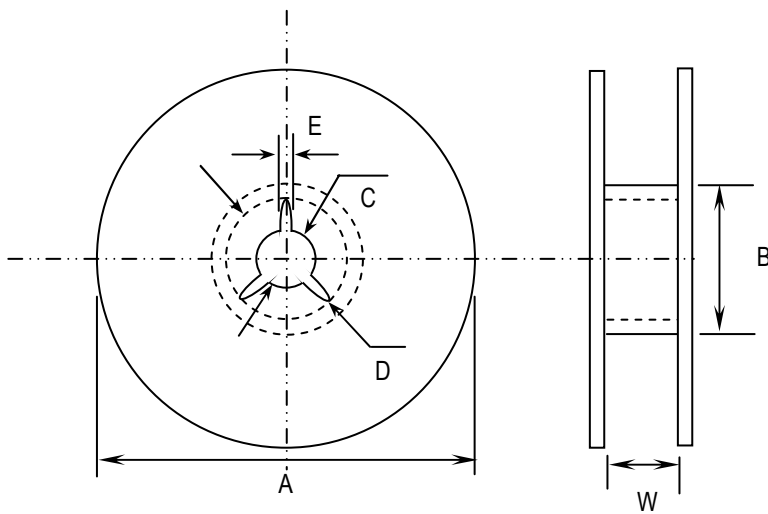

Unit:mm

Type	A	B	C	D	E	W
0201	φ 382 max	φ 50 min	φ 13± 0.5	φ 21± 0.8	2.0±0.5	10± 0.15
0402						
0603						
0805						
1206						
1210						
1808	φ 178±0.2	φ 60±0.2				13±0.3
1812						
1825						
2208						
2211						
2220						
2225						

Precautionary Notes:

1. Storage

Store the capacitors where the temperature and relative humidity don't exceed 40°C and 70%RH. We recommend that the capacitors be used within 6 months from the date of manufacturing. Store the products in the original package and do not open the outer wrapped, polyethylene bag, till just before usage. If it is open, seal it as soon as possible or keep it in a desiccant with a desiccation agent.

2. Construction of Board Pattern

Improper circuit layout and pad/land size may cause excessive or not enough solder amount on the PC board. Not enough solder may create weak joint, and excessive solder may increase the potential of mechanical or thermal cracks on the ceramic capacitor. Therefore we recommend the land size to be as shown in the following table:

2.1 Size and recommend land dimensions for reflow soldering .

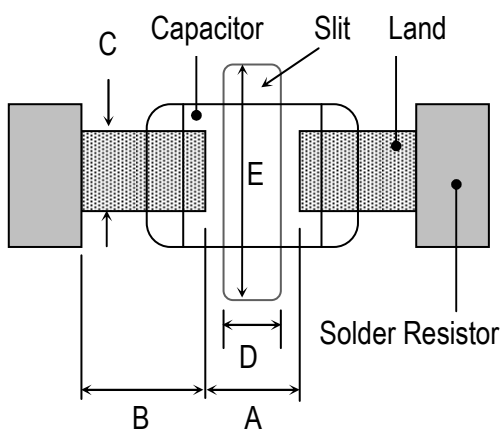

EIA Code	Chip (mm)		Land (mm)				
	L	W	A	B	C	D	E
0201	0.60	0.30	0.2~0.3	0.2~0.4	0.2~0.4	--	--
0402	1.00	0.50	0.3~0.5	0.3~0.5	0.4~0.6	--	--
0603	1.60	0.80	0.4~0.6	0.6~0.7	0.6~0.8	--	--
0805	2.00	1.25	0.7~0.9	0.6~0.8	0.8~1.1	--	--
1206	3.20	1.60	2.2~2.4	0.8~0.9	1.0~1.4	1.0~2.0	3.2~3.7
1210	3.20	2.50	2.2~2.4	1.0~1.2	1.8~2.3	1.0~2.0	4.1~4.6
1808	4.60	2.00	2.8~3.4	1.8~2.0	1.5~1.8	1.0~2.8	3.6~4.1
1812	4.60	3.20	2.8~3.4	1.8~2.0	2.3~3.0	1.0~2.8	4.8~5.3
1825	4.60	6.35	2.8~3.4	1.8~2.0	5.1~5.8	1.0~4.0	7.1~8.3
2208	5.70	2.00	4.0~4.6	2.0~2.2	1.5~1.8	1.0~4.0	3.6~4.1
2211	5.70	2.80	4.0~4.6	2.0~2.2	2.0~2.6	1.0~4.0	4.4~4.9
2220	5.70	5.00	4.0~4.6	2.0~2.2	3.5~4.8	1.0~4.0	6.6~7.1
2225	5.70	6.35	4.0~4.6	2.0~2.2	5.1~5.8	1.0~4.0	7.1~8.3

2.2 Mechanical strength varies according to location of chip capacitors on the P.C. board.

Design layout of components on the PC board such a way to minimize the stress imposed on the components, upon flexure of the boards in depanelization or other processes.

Component layout close to the edge of the board or the "depanelization line" is not recommended.

Susceptibility to stress is in the order of: a>b>c and d>e

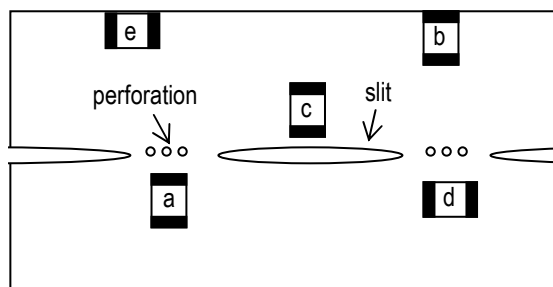

2.3 Layout Recommendation

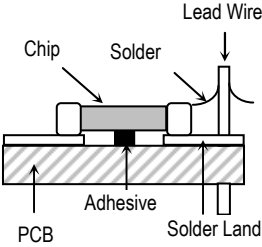
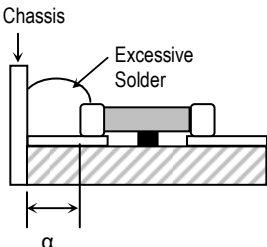
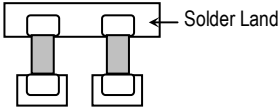
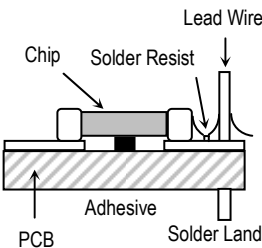
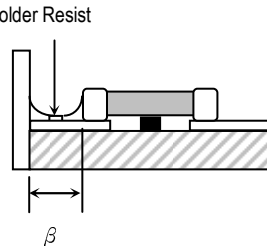
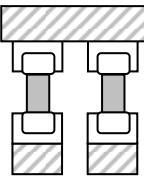
Example	Use of Common Solder Land	Solder With Chassis	Use of Common Solder Land With Other SMD
Need to Avoid			
Recommendation			

3. Mounting

3.1 Sometimes crack is caused by the impact load due to suction nozzle in pick and place operation.

In pick and place operation, if the low dead point is too low, excessive stress is applied to component. This may cause cracks in the ceramic capacitor, therefore it is required to move low dead point of a suction nozzle to the higher level to minimize the board warp age and stress on the components. Nozzle pressure is typically adjusted to 1N to 3N (static load) during the pick and place operation.

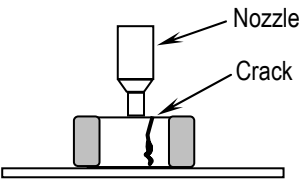
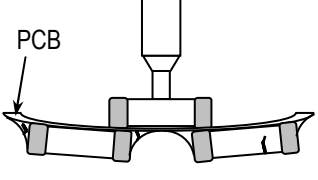
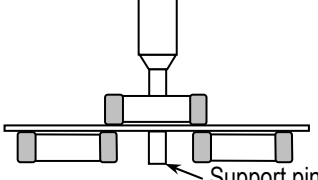
錯誤!	Excessive Stress	Warping of Board	Warping of Board
			

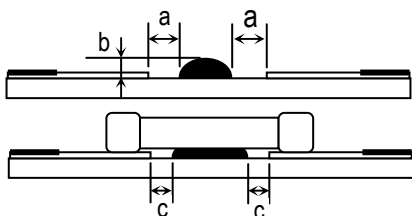
3.2 Amount of Adhesive

Example : 0805 & 1206

a	0.2mm min.
b	70 ~ 100 μm
c	Do not touch the solder land

4. Soldering

4.1. Wave Soldering

Most of components are wave soldered with solder at 230 to 250°C. Adequate care must be taken to prevent the potential of thermal cracks on the ceramic capacitors. Refer to the soldering methods below for optimum soldering benefits.

Recommend flow soldering temperature Profile

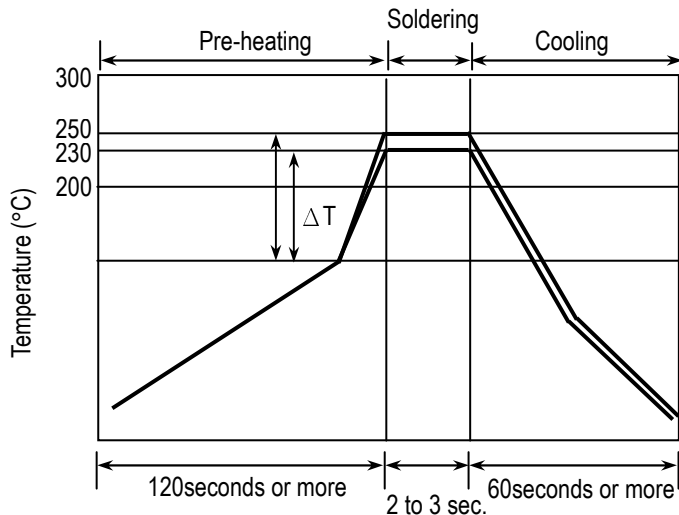

Soldering Method	Change in Temp.(°C)
1206 and Under	$\Delta T \leq 100\sim 130$ max.

To optimize the result of soldering, proper preheating is essential:

- 1) Preheat temperature is too low
 - a. Flux flows to easily
 - b. Possibility of thermal cracks
- 2) Preheat temperature is too high
 - a. Flux deteriorates even when oxide film is removed
 - b. Causes warping of circuit board
 - c. Loss of reliability in chip and other components

Cooling Condition:

Natural cooling using air is recommended. If the chips are dipped into a solvent for cleaning, the temperature difference (ΔT) between the solvent and the chips must be less than 100°C.

4.2 Reflow Soldering

Preheat and gradual increase in temperature to the reflow temperature is recommended to decrease the potential of thermal crack on the components. The recommended heating rate depends on the size of component, however it should not exceed 3°C/Sec.

Recommend reflow profile for Lead-Free soldering temperature Profile (MIL-STD-202G #210F)

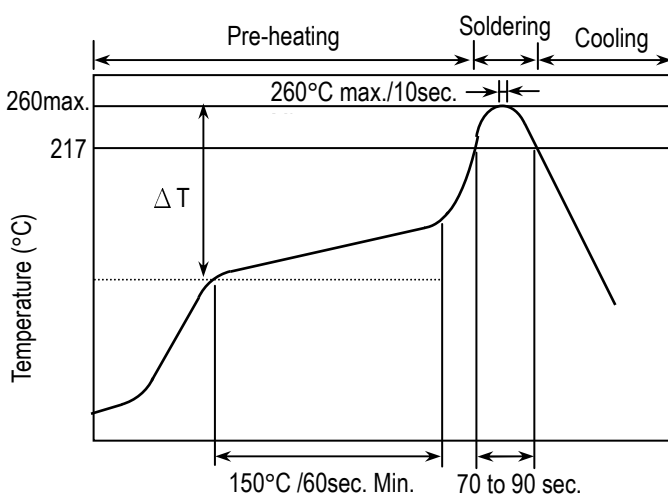

※ The cycles of soldering : Twice (max.)

Soldering Method	Change in Temp.(°C)
1206 and Under	$\Delta T \leq 190$ °C
1210 and Over	$\Delta T \leq 130$ °C

4.3 Hand Soldering

Sudden temperature change in components, results in a temperature gradient recommended in the following table, and therefore may cause internal thermal cracks in the components. In general a hand soldering method is not recommended unless proper preheating and handling practices have been taken. Care must also be taken not to touch the ceramic body of the capacitor with the tip of solder Iron.

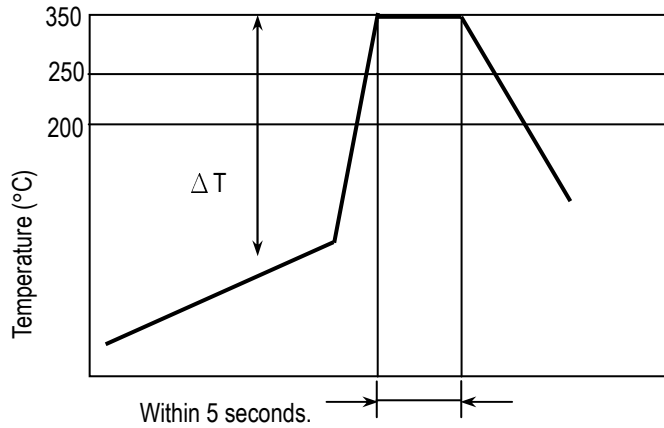

Soldering Method	Change in Temp.(°C)
1206 and Under	$\Delta T \leq 190 \text{ }^{\circ}\text{C}$
1210 and Over	$\Delta T \leq 130 \text{ }^{\circ}\text{C}$

How to Solder Repair by Solder Iron

- 1) Selection of the soldering iron tip
The required temperature of solder iron for any type of repair depends on the type of the tip, the substrate material, and the solder land size.
- 2) recommended solder iron condition
 - a.) Preheat the substrate to (60°C to 120°C) on a hot plate. Note that due to the heat loss, the actual setting of the hot plate may have to be higher. (For example 100°C to 150°C)
 - b.) Soldering iron power shall not exceed 30 W.
 - c.) Soldering iron tip diameter shall not exceed 3mm.
 - d.) Temperature of iron tip shall not exceed 350°C., and the process should be finished within 5 seconds. (refer to MIL-STD-202G)
 - f.) Do not touch the ceramic body with the tip of solder iron. Direct contact of the soldering iron tip to ceramic body may cause thermal cracks.
 - g.) After soldering operation, let the products cool down gradually in the room temperature.

5. Handling after chip mounted

5.1 Proper handling is recommended, since excessive bending and twist of the board, depends on the orientation of the chip on the board, may induce mechanical stress and cause internal crack in the capacitor.

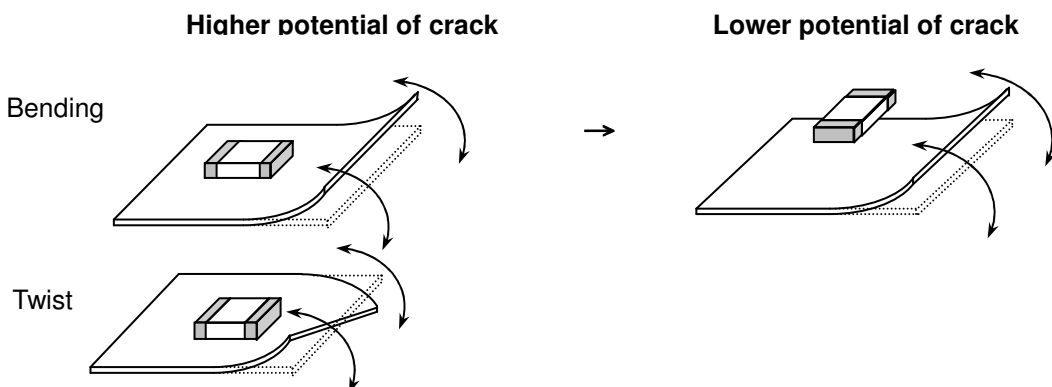

5.2 There is a potential of crack if board is warped due to excessive load by check pin

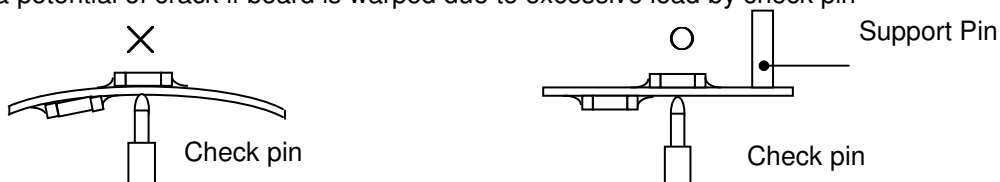

5.3 Mechanical stress due to warping and torsion.

- (a) Crack occurrence ratio will be increased by manual separation.
- (b) Crack occurrence ratio will be increased by tensile force , rather than compressive force.

× :Tensile Stress

○ :Compressive Stress

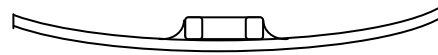
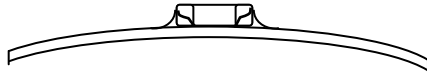

Capacitor Stress Analysis

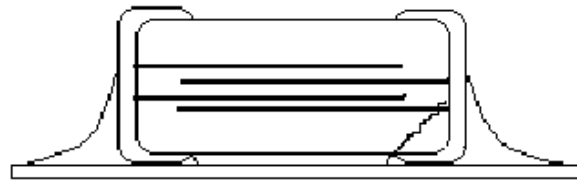
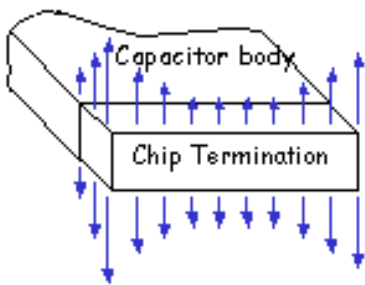

6. Handling of Loose Chip Capacitor

6.1 If dropped the chip capacitor may crack.

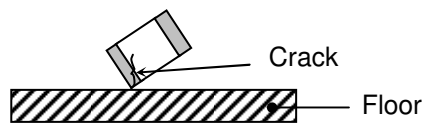

6.2 In piling and stacking of the P.C. boards after mounting for storage or handling, the corner of the P.C. board may hit the chip capacitor mounted on another board to cause crack.

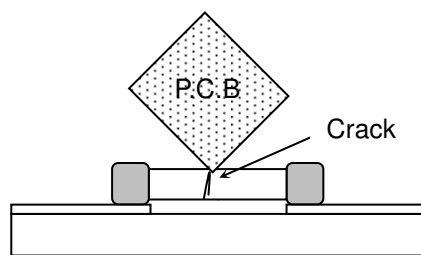

7. Safekeeping condition and period

For safekeeping of the products, we recommend to keep the storage temperature between +5 to +40 °C and under humidity of 20 to 75% RH. The shelf life of capacitors is 6 months.