

## 1. Scope

This specification is applies to Multilayer Ceramic Chip Capacitor (MLCC) for use in electric equipment for the voltage is ranging from 100V to 5KV.

The MLCC support for Lead-Free wave and reflow soldering, and electrical characteristic and reliability are same as before. **(This product compliant with the RoHS.)**

## 2. Parts Number Code

C	1206	N	680	J	102	T
---	------	---	-----	---	-----	---

(1)            (2)            (3)            (4)            (5)            (6)            (7)

### (1)Product

Product Code	
C	Multilayer Ceramic Chip Capacitor

### (2)Chip Size

Code	Length×Width	unit : mm(inch)
0201	0.60× 0.30	(.024× .011)
0402	1.00× 0.50	(.039× .020)
0603	1.60× 0.80	(.063× .031)
0805	2.00× 1.25	(.079× .049)
<b>1206</b>	<b>3.20× 1.60</b>	<b>(.126× .063)</b>
1210	3.20× 2.50	(.126× .098)
1808	4.60× 2.00	(.181× .079)
1812	4.60× 3.20	(.181× .125)
1825	4.60× 6.35	(.181× .250)
2208	5.70× 2.00	(.220× .197)
2211	5.70× 2.80	(.220× .110)
2220	5.70× 5.00	(.220× .197)
2225	5.70× 6.35	(.220× .250)

### (3)Temperature Characteristics

Code	Temperature Characteristic	Temperature Range	Temperature Coefficient
<b>N</b>	<b>NPO</b>	<b>-55℃~+125℃</b>	<b>30 ppm/℃</b>
L	SL	-30℃~+85℃	+350~-1000ppm
X	X7R	-55℃~+125℃	± 15%
B	X5R	-55℃~+85℃	± 15%
S	X6S	-55℃~+105℃	± 22%
Y	Y5V	-30℃~+85℃	+22/-82%
Z	Z5U	+10℃~+85℃	+22/-56%
E	Y5U	-30℃~+85℃	+22/-56%

### (4)Capacitance

unit :pico farads(pF)

Code	Nominal Capacitance (pF)
5R0	5.0
<b>680</b>	<b>68.0</b>
221	220.0
222	2,200.0
223	22,000.0
474	470,000.0
105	1,000,000.0
106	10,000,000.0

### (5)Capacitance Tolerance

Code	Tolerance	Nominal Capacitance
B	± 0.10 pF	Less Than 10 pF (Include 10 pF)
C	± 0.25 pF	
D	± 0.50 pF	More Than 10 pF
F	± 1.00 pF	
F	± 1.00 %	
G	± 2.00 %	
<b>J</b>	<b>± 5.00 %</b>	
K	± 10.0 %	
M	± 20.0 %	
Z	+80/-20 %	

### (6)Rated Voltage

Code	Rated Voltage (Vdc)
101	100
201	200
251	250
501	500
631	630
<b>102</b>	<b>1,000</b>
202	2,000
252	2,500
302	3,000
502	5,000

### (7)Tapping

Code	Type
<b>T</b>	<b>Tape &amp; Reel</b>
B	Bulk

※ If there is a decimal point, it shall be expressed by an English capital letter R

**3. Nominal Capacitance and Tolerance**
**3.1 Standard Combination of Nominal Capacitance and Tolerance**

Class	Characteristic	Tolerance		Nominal Capacitance
I	NPO / SL	Less Than 10 pF	B ( $\pm 0.10$ pF)	0.5,1,1.5,2,2.5,3
			C ( $\pm 0.25$ pF)	0.5,1,1.5,2,2.5,3,3.5,4,4.5,5
			D ( $\pm 0.50$ pF)	5,6,7,8,9,10
			F ( $\pm 1.00$ pF)	6,7,8,9,10
		More Than 10 pF	F ( $\pm 1.00$ %)	E-12, E-24 series
			G ( $\pm 2.00$ %)	
			J ( $\pm 5.00$ %)	
K ( $\pm 10.0$ %)				
II	X7R/X5R/X7E	K ( $\pm 10.0$ %), M ( $\pm 20.0$ %)		E-3, E-6 series
	Y5V	M ( $\pm 20.0$ %), Z (+80/-20 %)		E-3 series
	Z5U			
	Y5U			

**3.2 E series(standard Number)**

Standard No.	Application Capacitance											
E-3	1.0				2.2				4.7			
E-6	1.0		1.5		2.2		3.3		4.7		6.8	
E-12	1.0	1.2	1.5	1.8	2.2	2.7	3.3	3.9	4.7	5.6	6.8	8.2
E-24	1.0	1.2	1.5	1.8	2.2	2.7	3.3	3.9	4.7	5.6	6.8	8.2
	1.1	1.3	1.6	2.0	2.4	3.0	3.6	4.3	5.1	6.2	7.5	9.1

**4. Operation Temperature Range**

Class	Characteristic	Temperature Range	Reference Temp.
I	NPO	-55°C ~ +125°C	25°C
	SL	-25°C ~ +125°C	25°C
II	X7R	-55°C ~ +125°C	25°C
	X5R	-55°C ~ +85°C	25°C
	X6S	-55°C ~ +105°C	25°C
	Y5V	-30°C ~ +85°C	25°C
	Z5U	+10°C ~ +85°C	25°C
	Y5U	-30°C ~ +85°C	25°C
Other		-25°C ~ +85°C	25°C

**5. Storage Condition**

Storage Temperature : 5 to 40°C

Relative Humidity : 20 to 70 %

Storage Time : 6 months max.

**6. Dimensions**

**6.1 Configuration and Dimension :**

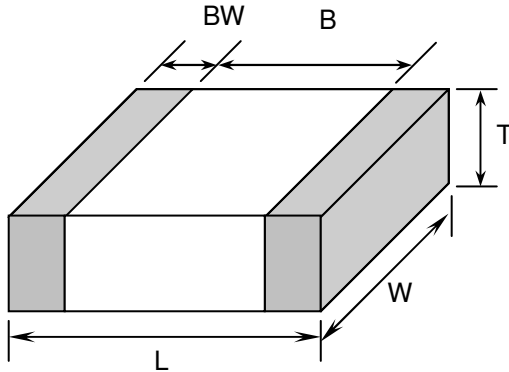

Unit:mm					
TYPE	L	W	T	B (min)	BW (min)
1206	3.20± 0.30	1.60± 0.20	1.25± 0.15	1.50	0.30

**6.2 Termination Type :**

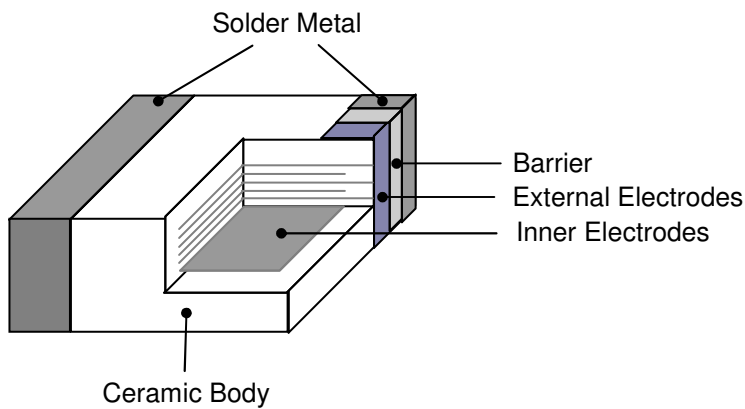

**7. Performance**

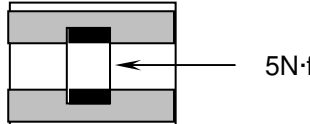
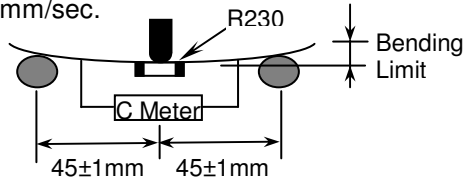
No.	Item	Specification	Test Condition									
1	Visual	No abnormal exterior appearance	Visual inspection									
2	Dimension	See Page 3	Visual inspection									
3	Insulation Resistance	10,000MΩ or 500/CΩ Product Whichever Is Smaller	V ≤ 500V, Rated Voltage V > 500V, Applied 500Vdc Charge Time : 60sec. Is applied less than 50mA current.									
4	Capacitance	Class I NPO/SL	Class I : NPO/SL <table border="1"> <thead> <tr> <th>Capacitance</th> <th>Frequency</th> <th>Voltage</th> </tr> </thead> <tbody> <tr> <td>C ≤ 100pF</td> <td>1MHz±10%</td> <td>1.0±0.2Vrms</td> </tr> <tr> <td>C &gt; 100pF</td> <td>1KHz±10%</td> <td></td> </tr> </tbody> </table>	Capacitance	Frequency	Voltage	C ≤ 100pF	1MHz±10%	1.0±0.2Vrms	C > 100pF	1KHz±10%	
		Capacitance		Frequency	Voltage							
C ≤ 100pF	1MHz±10%	1.0±0.2Vrms										
C > 100pF	1KHz±10%											
Class II	Class II : <table border="1"> <thead> <tr> <th colspan="2">Frequency</th> <th>Voltage</th> </tr> </thead> <tbody> <tr> <td>X7R</td> <td>1KHz±10%</td> <td>1.0±0.2Vrms</td> </tr> <tr> <td>Z5U/Y5U</td> <td>1KHz±10%</td> <td>1.0±0.2Vrms</td> </tr> </tbody> </table> Perform a heat temperature at 150±5°C for 30min. then place room temp. for 24±2hr.	Frequency		Voltage	X7R	1KHz±10%	1.0±0.2Vrms	Z5U/Y5U	1KHz±10%	1.0±0.2Vrms		
Frequency		Voltage										
X7R	1KHz±10%	1.0±0.2Vrms										
Z5U/Y5U	1KHz±10%	1.0±0.2Vrms										
5	Q	Class I NPO/SL	<table border="1"> <thead> <tr> <th colspan="2">Frequency</th> <th>Voltage</th> </tr> </thead> <tbody> <tr> <td>X7R</td> <td>1KHz±10%</td> <td>1.0±0.2Vrms</td> </tr> <tr> <td>Z5U/Y5U</td> <td>1KHz±10%</td> <td>1.0±0.2Vrms</td> </tr> </tbody> </table> Perform a heat temperature at 150±5°C for 30min. then place room temp. for 24±2hr.	Frequency		Voltage	X7R	1KHz±10%	1.0±0.2Vrms	Z5U/Y5U	1KHz±10%	1.0±0.2Vrms
	Frequency			Voltage								
X7R	1KHz±10%	1.0±0.2Vrms										
Z5U/Y5U	1KHz±10%	1.0±0.2Vrms										
Tan δ	Class II	<table border="1"> <thead> <tr> <th>Char.</th> <th>Maximum</th> </tr> </thead> <tbody> <tr> <td>X7R</td> <td>2.5%</td> </tr> <tr> <td>Z5U/Y5U</td> <td>4.0%</td> </tr> </tbody> </table>	Char.	Maximum	X7R	2.5%	Z5U/Y5U	4.0%				
Char.	Maximum											
X7R	2.5%											
Z5U/Y5U	4.0%											
6	Withstanding Voltage	No dielectric breakdown or mechanical breakdown	V < 500V : 200% Rated Voltage 500V ≤ V < 1000V: 150% Rated Voltage 1000 ≤ V : 120% Rated Voltage for 1~5 sec. Current is limited to less than 50mA.  ※ Withstanding voltage testing requires immersion of the element in a isolation fluid prevent arcing on the chip surface, at voltage over 1000Vdc.									
7	Temperature Capacitance Coefficient	Class I	Char.	Temp. Range	Cap. Change(%)	Class I : [(C2-C1)/C1(T2-T1)] × 100% Class II : (C2-C1)/C1 × 100% T1: Standard temperature (25°C) T2: Test temperature C1:Capacitance at standard temperature(25°C) C2: Capacitance at test temperature (T2)						
			NPO	-55°C ~ +125°C	± 30 ppm/°C							
		SL	-30°C ~ +85°C	+350~-1000ppm								
		Class II	Char.	Temp. Range	Cap. Change(%)							
			X7R	-55°C ~ +125°C	± 15%							
Y5U	-30°C ~ +85°C		+22% ~ -56%									
Z5U	+10°C ~ +85°C	+22% ~ -56%										
8	Adhesive Strength of Termination	No indication of peeling shall occur on the terminal electrode.	A 5N·f (≅ 0.5Kg·f) pull force shall be applied for 10± 1 second.  									
9	Resistance to Flexure of Substrate	Appearance	No mechanical damage shall be occur.		Bending shall be applied to the 1.0 mm with 1.0 mm/sec.  							
		C-Meter	Capacitance Change									
			Char.	Cap. Change								
			NPO	≤ ± 5.0%								
			SL	≤ ± 5.0%								
X7R	≤ ± 12.5%											
Y5U/Z5U	≤ ± 30.0%											

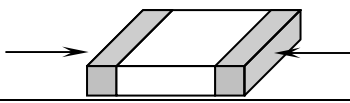
No.	Item	Specification	Test Condition															
10	Solderability	More than 90% of the terminal surface is to be soldered newly, so metal part does not come out or dissolve . 	Solder Temperature : $245 \pm 5^\circ\text{C}$ Dip Time : $5 \pm 0.5$ sec. Immersing Speed : $25 \pm 10\%$ mm/s Solder : H63A Flux : Rosin Preheat : At $80 \sim 120^\circ\text{C}$ for $10 \sim 30$ sec.															
11	Resistance To Soldering Heat	Appearance	No mechanical damage shall occur.															
		Capacitance	Characteristic	Cap. Change														
			Class I (NPO/SL)	Within $\pm 2.5\%$ or $\pm 0.25\text{pF}$ whichever is larger of initial value														
			Class II	<table border="1"> <tr> <td>X7R</td> <td>Within <math>\pm 10\%</math></td> </tr> <tr> <td>Z5U/Y5U</td> <td>Within <math>\pm 20\%</math></td> </tr> </table>	X7R	Within $\pm 10\%$	Z5U/Y5U	Within $\pm 20\%$										
		X7R	Within $\pm 10\%$															
		Z5U/Y5U	Within $\pm 20\%$															
		Q Class I	To satisfy the specified initial value															
Tan $\delta$ Class II	To satisfy the specified initial value																	
Insulation Resistance	To satisfy the specified initial value																	
Withstand Voltage	To satisfy the specified initial value																	
			Class II capacitor shall be set for $48 \pm 4$ hours at room temperature after one hour heat treatment at $150 \pm 0/-10^\circ\text{C}$ before initial measure. Preheat : At $150 \pm 10^\circ\text{C}$ For $60 \sim 120$ sec. Dip : Solder Temperature of $260 \pm 5^\circ\text{C}$ Dip Time : $10 \pm 1$ sec. Immersing Speed : $25 \pm 10\%$ mm/s Solder : H63A Flux : Rosin Measure at room temperature after cooling for Class I : $24 \pm 2$ Hours Class II : $48 \pm 4$ Hours															
12	Temperature Cycle	Appearance	No mechanical damage shall occur															
		Capacitance	Characteristic	Cap. Change														
			Class I (NPO/SL)	Within $\pm 2.5\%$ or $\pm 0.25\text{pF}$ whichever is larger of initial value														
			Class II	<table border="1"> <tr> <td>X7R</td> <td>Within <math>\pm 7.5\%</math></td> </tr> <tr> <td>Z5U/Y5U</td> <td>Within <math>\pm 20\%</math></td> </tr> </table>	X7R	Within $\pm 7.5\%$	Z5U/Y5U	Within $\pm 20\%$										
		X7R	Within $\pm 7.5\%$															
		Z5U/Y5U	Within $\pm 20\%$															
		Q Class I	To satisfy the specified initial value															
Tan $\delta$ Class II	To satisfy the specified initial value																	
Insulation Resistance	To satisfy the specified initial value																	
			Class II capacitor shall be set for $48 \pm 4$ hours at room temperature after one hour heat treatment at $150 \pm 0/-10^\circ\text{C}$ before initial measure. Capacitor shall be subjected to five cycles of the temperature cycle as following: <table border="1" data-bbox="954 1209 1452 1377"> <thead> <tr> <th>Step</th> <th>Temp.(<math>^\circ\text{C}</math>)</th> <th>Time(min)</th> </tr> </thead> <tbody> <tr> <td>1</td> <td>Min Rated Temp. <math>+0/-3</math></td> <td>30</td> </tr> <tr> <td>2</td> <td>25</td> <td>3</td> </tr> <tr> <td>3</td> <td>Max Rated Temp. <math>+3/-0</math></td> <td>30</td> </tr> <tr> <td>4</td> <td>25</td> <td>3</td> </tr> </tbody> </table> Measure at room temperature after cooling for Class I : $24 \pm 2$ Hrs Class II : $48 \pm 4$ Hrs Solder the capacitor on P.C. board shown in Fig 2. before testing.	Step	Temp.( $^\circ\text{C}$ )	Time(min)	1	Min Rated Temp. $+0/-3$	30	2	25	3	3	Max Rated Temp. $+3/-0$	30	4	25	3
Step	Temp.( $^\circ\text{C}$ )	Time(min)																
1	Min Rated Temp. $+0/-3$	30																
2	25	3																
3	Max Rated Temp. $+3/-0$	30																
4	25	3																
13	Humidity	Appearance	No mechanical damage shall occur															
		Capacitance	Characteristic	Cap. Change														
			Class I (NPO/SL)	Within $\pm 5.0\%$ or $\pm 0.5\text{pF}$ whichever is larger of initial value														
			Class II	<table border="1"> <tr> <td>X7R</td> <td>Within <math>\pm 15\%</math></td> </tr> <tr> <td>Z5U/Y5U</td> <td>Within <math>\pm 30\%</math></td> </tr> </table>	X7R	Within $\pm 15\%$	Z5U/Y5U	Within $\pm 30\%$										
		X7R	Within $\pm 15\%$															
		Z5U/Y5U	Within $\pm 30\%$															
		Q Class I	More Than $30\text{pF}$ : $Q \geq 350$ $30\text{pF}$ & Below: $Q \geq 275 + 2.5 \times C$															
Tan $\delta$ Class II	Char.	Maximum																
	X7R	5.0%																
Insulation Resistance	Z5U/Y5U	5.0%																
	1,000M $\Omega$ or 50/C $\Omega$ whichever is smaller.																	
			Class II capacitor shall be set for $48 \pm 4$ hours at room temperature after one hour heat treatment at $150 \pm 0/-10^\circ\text{C}$ before initial measure. Temperature : $40 \pm 2^\circ\text{C}$ Relative Humidity : $90 \sim 95\% \text{RH}$ Test Time : $500 + 12/-0$ Hr Measure at room temperature after cooling for Class I : $24 \pm 2$ Hrs Class II : $48 \pm 4$ Hrs Solder the capacitor on P.C. board shown in Fig 2. before testing.															

No.	Item	Specification	Test Condition								
14	High Temperat. Load	Appearance	Class II capacitors applied DC voltage (following table) is applied for one hour at maximum operation temperature $\pm 3^{\circ}\text{C}$ then shall be set for $48 \pm 4$ hours at room temperature and the initial measurement shall be conducted. Applied Voltage : <table border="1" data-bbox="962 517 1473 728"> <thead> <tr> <th>Rated Voltage</th> <th>Applied Voltage</th> </tr> </thead> <tbody> <tr> <td><math>V \leq 250\text{Vdc}</math></td> <td>150% Rated Voltage</td> </tr> <tr> <td>Less Than 1KVdc</td> <td>120% Rated Voltage</td> </tr> <tr> <td>More Than 1KVdc(include 1KV)</td> <td>100% Rated Voltage</td> </tr> </tbody> </table>	Rated Voltage	Applied Voltage	$V \leq 250\text{Vdc}$	150% Rated Voltage	Less Than 1KVdc	120% Rated Voltage	More Than 1KVdc(include 1KV)	100% Rated Voltage
		Rated Voltage		Applied Voltage							
		$V \leq 250\text{Vdc}$		150% Rated Voltage							
		Less Than 1KVdc		120% Rated Voltage							
		More Than 1KVdc(include 1KV)		100% Rated Voltage							
		Capacitance		Characteristic	Cap. Change						
				Class I (NPO/SL)	Within $\pm 3.0\%$ or $\pm 0.3\text{pF}$ whichever is larger						
Class II	<table border="1" data-bbox="531 459 699 526"> <tr> <td>X7R</td> <td>Within <math>\pm 15\%</math></td> </tr> <tr> <td>Z5U/Y5U</td> <td>Within <math>\pm 30\%</math></td> </tr> </table>		X7R	Within $\pm 15\%$	Z5U/Y5U	Within $\pm 30\%$					
X7R	Within $\pm 15\%$										
Z5U/Y5U	Within $\pm 30\%$										
Q	More Than 30pF : $Q \geq 350$ 30pF & Below: $Q \geq 275 + 2.5 \times C$										
Tan $\delta$	Char.	maximum									
	Class II	<table border="1" data-bbox="459 622 627 689"> <tr> <td>X7R</td> <td>5.0%</td> </tr> <tr> <td>Z5U/Y5U</td> <td>5.0%</td> </tr> </table>	X7R	5.0%	Z5U/Y5U	5.0%					
X7R	5.0%										
Z5U/Y5U	5.0%										
Insulation Resistance	1,000M $\Omega$ or 50/C $\Omega$ whichever is smaller. (C in Farad)										
15	Vibration	Appearance	Solder the capacitor on P.C. Board shown in Fig 2. before testing.  Vibrate the capacitor with amplitude of 1.5mm P-P changing the frequencies from 10Hz to 55Hz and back to 10Hz in about 1 min.  Repeat this for 2 hours each in 3perpendicular directions.								
		Capacitance		Characteristic	Cap. Change						
				Class I (NPO/SL)	Within $\pm 2.5\%$ or $\pm 0.25\text{pF}$ whichever is larger						
				Class II	<table border="1" data-bbox="531 1193 699 1261"> <tr> <td>X7R</td> <td>Within <math>\pm 7.5\%</math></td> </tr> <tr> <td>Z5U/Y5U</td> <td>Within <math>\pm 20\%</math></td> </tr> </table>	X7R	Within $\pm 7.5\%$	Z5U/Y5U	Within $\pm 20\%$		
		X7R		Within $\pm 7.5\%$							
		Z5U/Y5U		Within $\pm 20\%$							
		Q		To satisfy the specified initial value							
Tan $\delta$	To satisfy the specified initial value										
Insulation Resistance	To satisfy the specified initial value										

**Fig.1**  
**P.C. Board for Bending Strength Test**

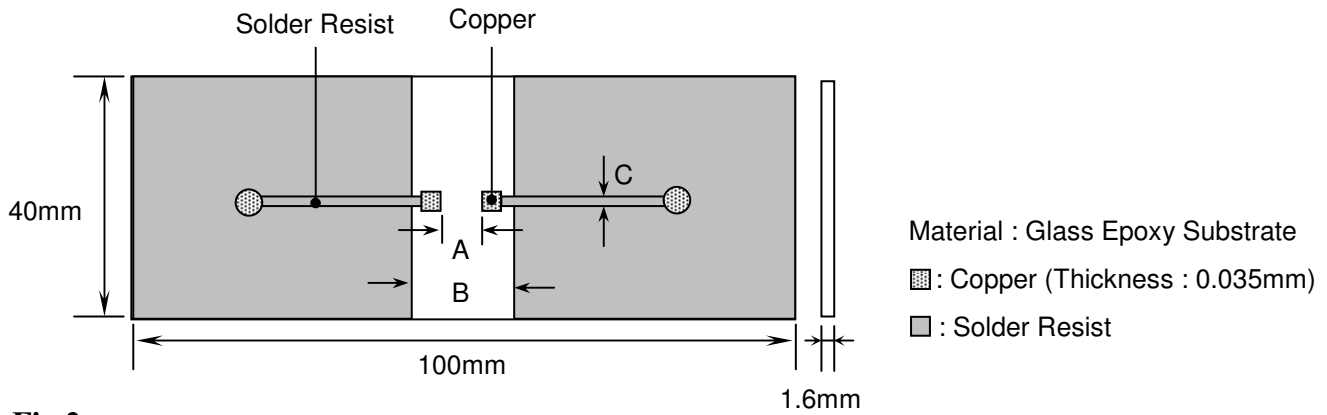

**Fig.2**  
**Test Substrate**

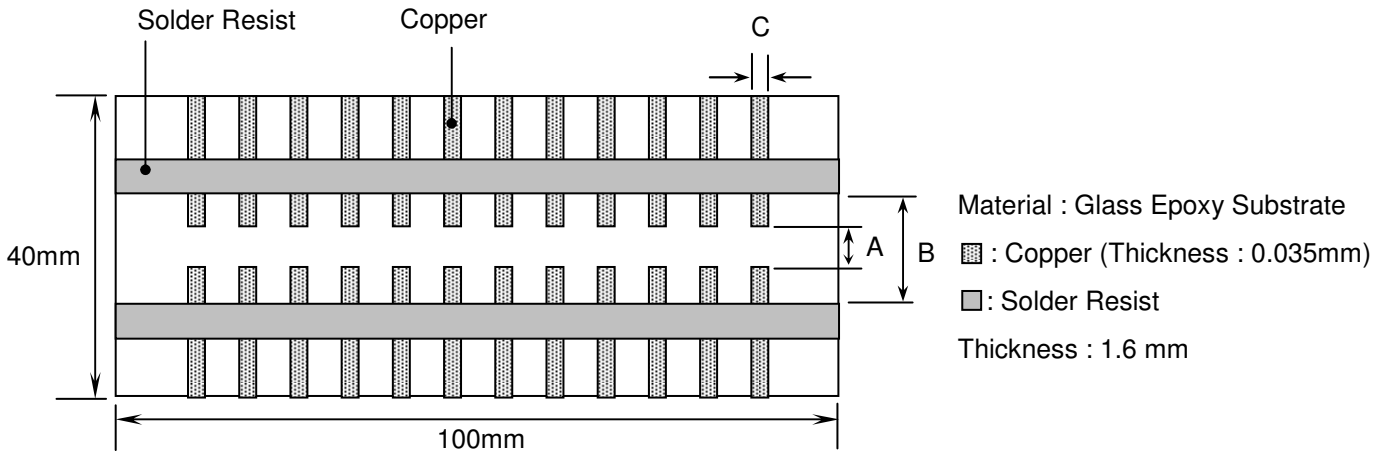

Unit:mm

Type	A	B	C
0201	0.2	0.9	0.4
0402	0.5	1.5	0.6
0603	1.0	3.0	1.0
0805	1.2	4.0	1.6
1206	2.2	5.0	2.0
1210	2.2	5.0	2.9
1808	3.5	7.0	2.5
1812	3.5	7.0	3.7
2208	4.5	8.0	2.5
2211	4.5	8.0	3.0
2220	4.5	8.0	5.6

**8. Packing**
**8.1 Bulk Packing**

According to customer request.

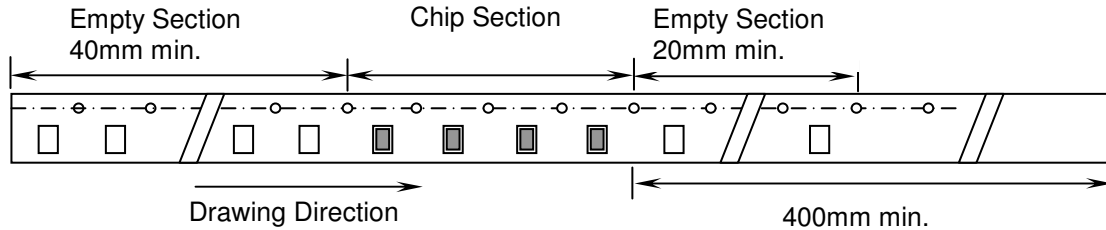
**8.2 Chip Capacitors Tape Packing**

**8.3 Material And Quantity**

Tape	0201	0402	0603/0805	
Material	$T \leq 0.33\text{mm}$	$T \leq 0.55\text{mm}$	$T \leq 0.90\text{mm}$	$T > 0.90\text{mm}$
Paper	15,000 pcs/Reel	10,000 pcs/Reel	4,000 pcs/Reel	NA
Plastic	NA	NA	NA	3,000 pcs/Reel

Tape	1206			1210/1808	
Material	$T \leq 0.90\text{mm}$	$0.90\text{mm} < T \leq 1.25\text{mm}$	$T > 1.25\text{mm}$	$T \leq 1.25\text{mm}$	$T > 1.25\text{mm}$
Paper	4,000 pcs/Reel	NA	NA	NA	NA
Plastic	NA	3,000 pcs/Reel	2,000 pcs/Reel	3000 pcs/Reel	2000 pcs/Reel

Tape	1812/1825/2211/2220		2225		2208
Material	$T \leq 2.20\text{mm}$	$T > 2.20\text{mm}$	$T \leq 2.20\text{mm}$	$T > 2.20\text{mm}$	$T \leq 2.20\text{mm}$
Paper	NA	NA	NA	NA	NA
Plastic	1000 pcs/Reel	700 pcs/Reel	1000 pcs/Reel	400 pcs/Reel	1000 pcs/Reel

NA : Not Available

**8.4 Cover Tape Reel Off Force**
**9.4.1 Peel-Off Force**

$$5 \text{ g}\cdot\text{f} \leq \text{Peel-Off Force} \leq 70 \text{ g}\cdot\text{f}$$

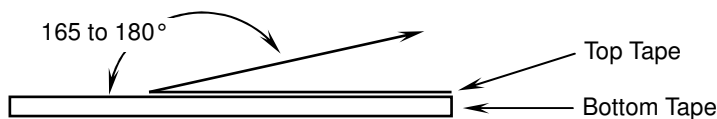
**9.4.2 Measure Method**

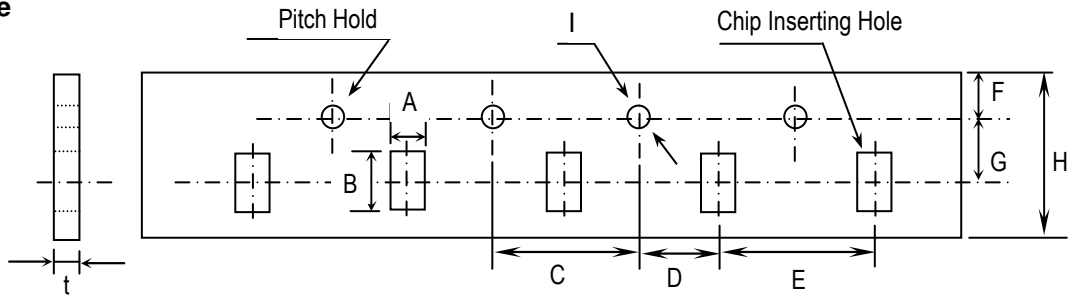

**8.5 Paper Tape**

Unit:mm

TYPE	A	B	C	D	E
0201	0.37± 0.1	0.67± 0.1	4.00± 0.1	2.00± 0.05	2.00± 0.1
0402	0.61± 0.1	1.20± 0.1			4.00± 0.1
0603	1.10± 0.2	1.90± 0.2			
0805	1.50± 0.2	2.30± 0.2			
1206	1.90± 0.2	3.50± 0.2			
1210	2.90± 0.2	3.60± 0.2			

TYPE	F	G	H	I	t
0201	1.75± 0.10	3.50± 0.05	8.0± 0.30	φ 1.50 +0.10/-0	1.10 max.
0402					
0603					
0805					
1206					
1210					

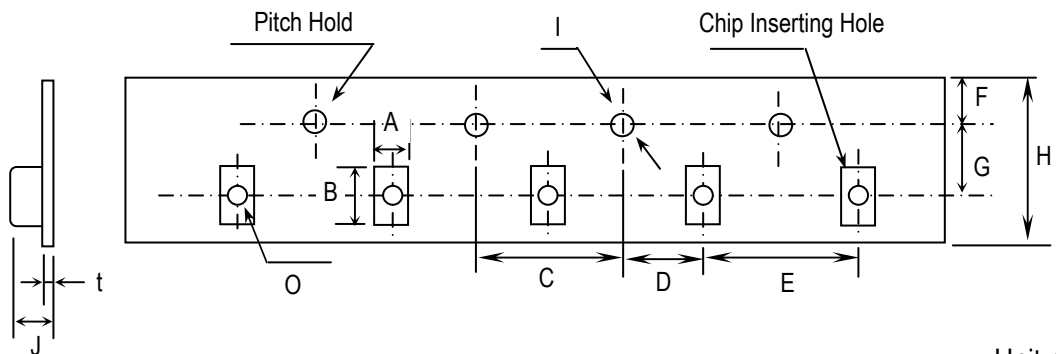
**8.6 Plastic Tape**

Unit:mm

Type	A	B	C	D	E	F
0805	1.5±0.2	2.3±0.2	4.0± 0.1	2.0± 0.05	4.0± 0.1	1.75± 0.1
1206	1.9±0.2	3.5±0.2				
1210	2.9±0.2	3.6±0.2				
1808	2.5±0.2	4.9±0.2			8.0± 0.1	
1812	3.6±0.2	4.9±0.2				
1825	6.9±0.2	4.9±0.2				
2208	2.5±0.2	6.1±0.2				
2211	3.2±0.2	6.1±0.2				
2220	5.4±0.2	6.1±0.2				
2225	6.9±0.2	6.1±0.2				

Type	G	H	I	J	t	O
0805	3.5± 0.05	8.0± 0.3	$\varphi$ 1.5+0.1/-0	3.0 max.	0.3 max.	0.15 min.
1206						
1210						
1808	5.5± 0.05	12.0 ± 0.3		4.0 max.		
1812						
1825						
2208						
2211						
2220						
2225						

**8.7 Reel Dimensions**

Reel Material : Polystyrene

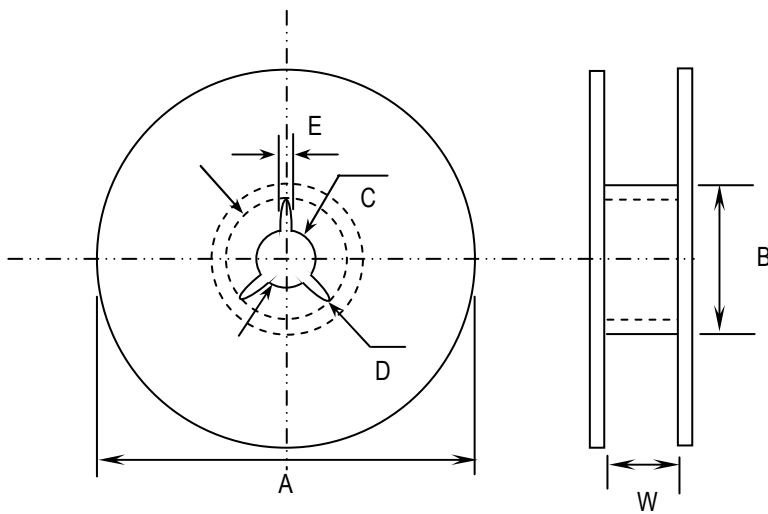

Unit:mm

Type	A	B	C	D	E	W
0201	$\varphi$ 382 max	$\varphi$ 50 min	$\varphi$ 13± 0.5	$\varphi$ 21± 0.8	2.0±0.5	10± 0.15
0402						
0603						
0805						
1206						
1210						
1808	$\varphi$ 178±0.2	$\varphi$ 60±0.2				13±0.3
1812						
1825						
2208						
2211						
2220						
2225						

## Precautionary Notes:

### 1. Storage

Store the capacitors where the temperature and relative humidity don't exceed 40°C and 70%RH. We recommend that the capacitors be used within 6 months from the date of manufacturing. Store the products in the original package and do not open the outer wrapped, polyethylene bag, till just before usage. If it is open, seal it as soon as possible or keep it in a desiccant with a desiccation agent.

### 2. Construction of Board Pattern

Improper circuit layout and pad/land size may cause excessive or not enough solder amount on the PC board. Not enough solder may create weak joint, and excessive solder may increase the potential of mechanical or thermal cracks on the ceramic capacitor. Therefore we recommend the land size to be as shown in the following table:

2.1 Size and recommend land dimensions for reflow soldering .

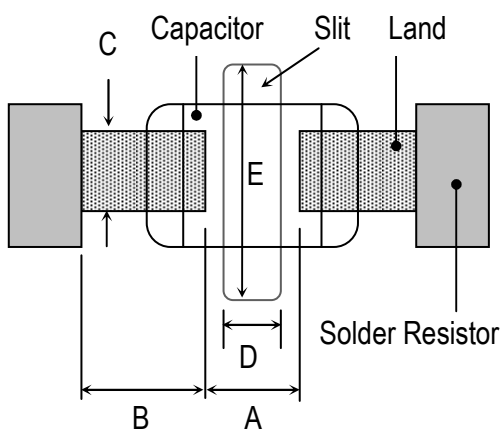

EIA Code	Chip (mm)		Land (mm)				
	L	W	A	B	C	D	E
0201	0.60	0.30	0.2~0.3	0.2~0.4	0.2~0.4	--	--
0402	1.00	0.50	0.3~0.5	0.3~0.5	0.4~0.6	--	--
0603	1.60	0.80	0.4~0.6	0.6~0.7	0.6~0.8	--	--
0805	2.00	1.25	0.7~0.9	0.6~0.8	0.8~1.1	--	--
1206	3.20	1.60	2.2~2.4	0.8~0.9	1.0~1.4	1.0~2.0	3.2~3.7
1210	3.20	2.50	2.2~2.4	1.0~1.2	1.8~2.3	1.0~2.0	4.1~4.6
1808	4.60	2.00	2.8~3.4	1.8~2.0	1.5~1.8	1.0~2.8	3.6~4.1
1812	4.60	3.20	2.8~3.4	1.8~2.0	2.3~3.0	1.0~2.8	4.8~5.3
1825	4.60	6.35	2.8~3.4	1.8~2.0	5.1~5.8	1.0~4.0	7.1~8.3
2208	5.70	2.00	4.0~4.6	2.0~2.2	1.5~1.8	1.0~4.0	3.6~4.1
2211	5.70	2.80	4.0~4.6	2.0~2.2	2.0~2.6	1.0~4.0	4.4~4.9
2220	5.70	5.00	4.0~4.6	2.0~2.2	3.5~4.8	1.0~4.0	6.6~7.1
2225	5.70	6.35	4.0~4.6	2.0~2.2	5.1~5.8	1.0~4.0	7.1~8.3

2.2 Mechanical strength varies according to location of chip capacitors on the P.C. board.

Design layout of components on the PC board such a way to minimize the stress imposed on the components, upon flexure of the boards in depanelization or other processes.

Component layout close to the edge of the board or the "depanelization line" is not recommended.

Susceptibility to stress is in the order of:  $a > b > c$  and  $d > e$

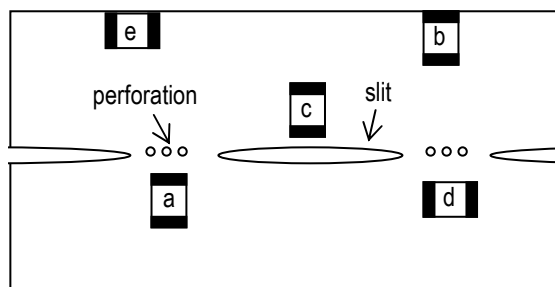

**2.3 Layout Recommendation**

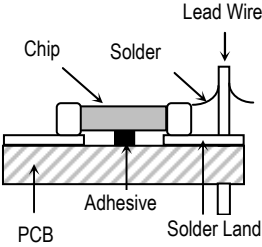
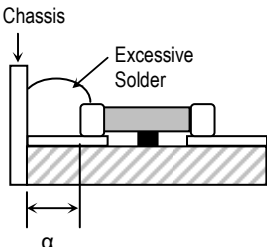
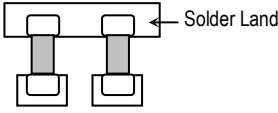
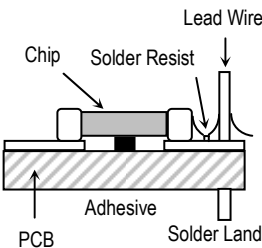
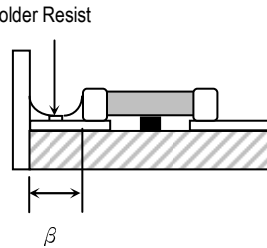
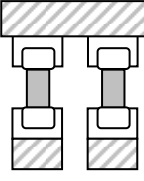
Example	Use of Common Solder Land	Solder With Chassis	Use of Common Solder Land With Other SMD
Need to Avoid			
Recommendation			

**3. Mounting**

3.1 Sometimes crack is caused by the impact load due to suction nozzle in pick and place operation.

In pick and place operation, if the low dead point is too low, excessive stress is applied to component. This may cause cracks in the ceramic capacitor, therefore it is required to move low dead point of a suction nozzle to the higher level to minimize the board warp age and stress on the components. Nozzle pressure is typically adjusted to 1N to 3N (static load) during the pick and place operation.

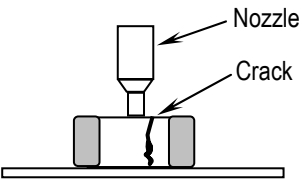
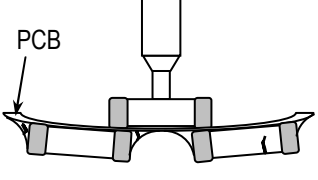
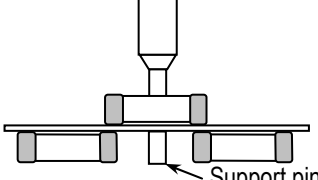
錯誤!	Excessive Stress	Warping of Board	Warping of Board
			

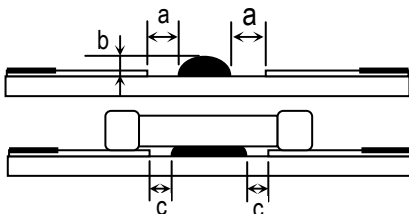
**3.2 Amount of Adhesive**

Example : 0805 & 1206

a	0.2mm min.
b	70 ~ 100 μm
c	Do not touch the solder land

## 4. Soldering

### 4.1. Wave Soldering

Most of components are wave soldered with solder at 230 to 250°C. Adequate care must be taken to prevent the potential of thermal cracks on the ceramic capacitors. Refer to the soldering methods below for optimum soldering benefits.

#### Recommend flow soldering temperature Profile

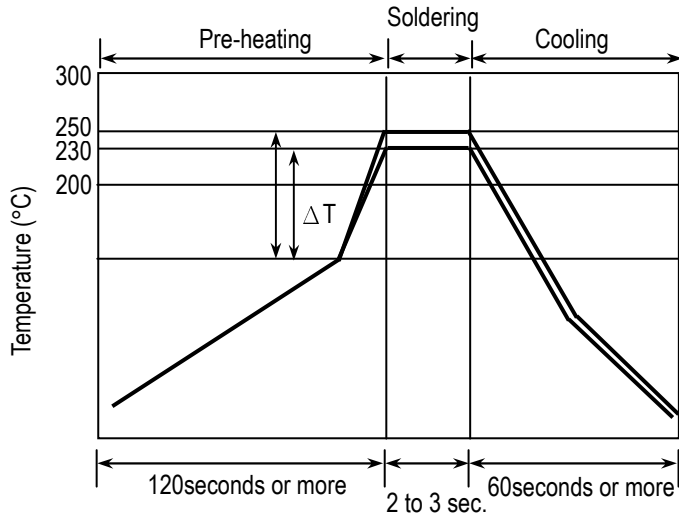

Soldering Method	Change in Temp.(°C)
1206 and Under	$\Delta T \leq 100\sim 130$ max.

To optimize the result of soldering, proper preheating is essential:

- 1) Preheat temperature is too low
  - a. Flux flows to easily
  - b. Possibility of thermal cracks
- 2) Preheat temperature is too high
  - a. Flux deteriorates even when oxide film is removed
  - b. Causes warping of circuit board
  - c. Loss of reliability in chip and other components

#### Cooling Condition:

Natural cooling using air is recommended. If the chips are dipped into a solvent for cleaning, the temperature difference ( $\Delta T$ ) between the solvent and the chips must be less than 100°C.

### 4.2 Reflow Soldering

Preheat and gradual increase in temperature to the reflow temperature is recommended to decrease the potential of thermal crack on the components. The recommended heating rate depends on the size of component, however it should not exceed 3°C/Sec.

#### Recommend reflow profile for Lead-Free soldering temperature Profile (MIL-STD-202G #210F)

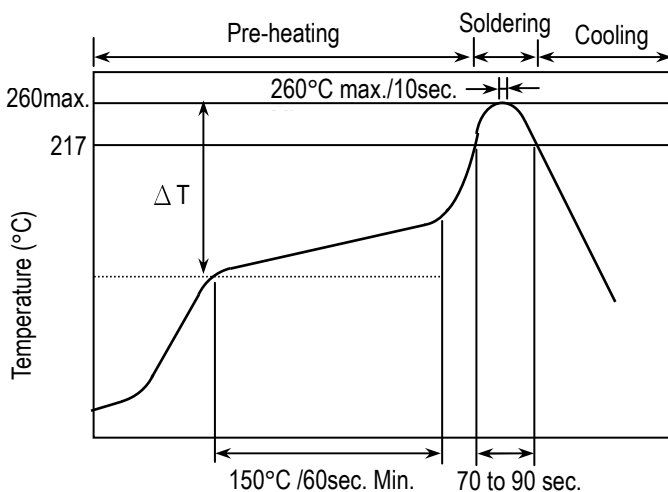

※ The cycles of soldering : Twice (max.)

Soldering Method	Change in Temp.(°C)
1206 and Under	$\Delta T \leq 190$ °C
1210 and Over	$\Delta T \leq 130$ °C

**4.3 Hand Soldering**

Sudden temperature change in components, results in a temperature gradient recommended in the following table, and therefore may cause internal thermal cracks in the components. In general a hand soldering method is not recommended unless proper preheating and handling practices have been taken. Care must also be taken not to touch the ceramic body of the capacitor with the tip of solder Iron.

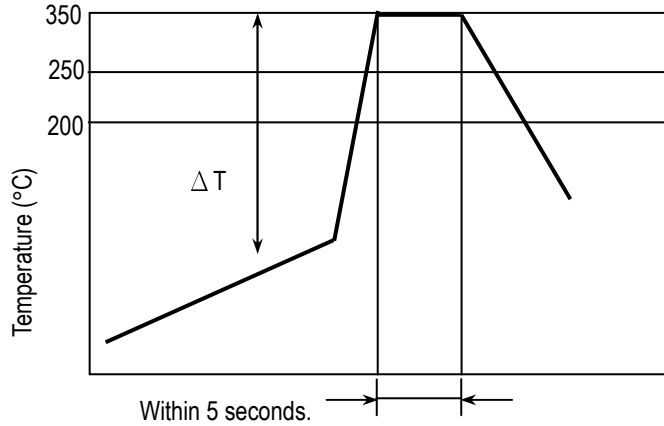

Soldering Method	Change in Temp.( °C)
1206 and Under	$\Delta T \leq 190 \text{ }^{\circ}\text{C}$
1210 and Over	$\Delta T \leq 130 \text{ }^{\circ}\text{C}$

**How to Solder Repair by Solder Iron**

- 1) Selection of the soldering iron tip  
The required temperature of solder iron for any type of repair depends on the type of the tip, the substrate material, and the solder land size.
- 2) recommended solder iron condition
  - a.) Preheat the substrate to (60°C to 120°C) on a hot plate. Note that due to the heat loss, the actual setting of the hot plate may have to be higher. (For example 100°C to 150°C)
  - b.) Soldering iron power shall not exceed 30 W.
  - c.) Soldering iron tip diameter shall not exceed 3mm.
  - d.) Temperature of iron tip shall not exceed 350°C., and the process should be finished within 5 seconds. ( refer to MIL-STD-202G)
  - f.) Do not touch the ceramic body with the tip of solder iron. Direct contact of the soldering iron tip to ceramic body may cause thermal cracks.
  - g.) After soldering operation, let the products cool down gradually in the room temperature.

**5. Handling after chip mounted**

5.1 Proper handling is recommended, since excessive bending and twist of the board, depends on the orientation of the chip on the board, may induce mechanical stress and cause internal crack in the capacitor.

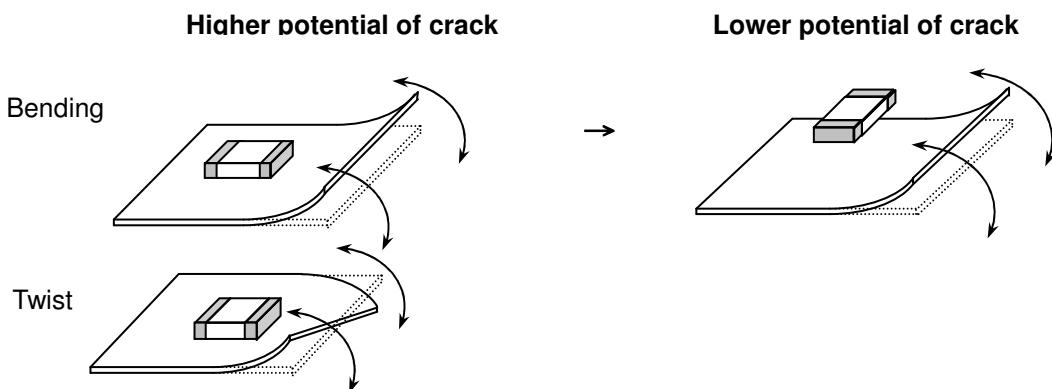

5.2 There is a potential of crack if board is warped due to excessive load by check pin

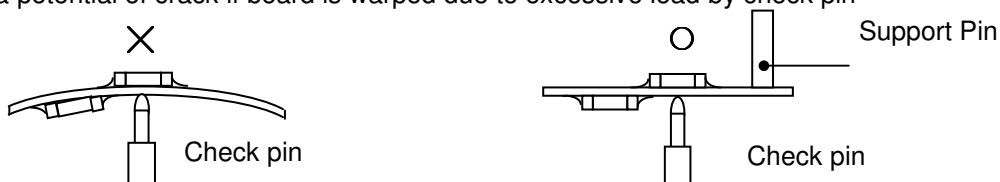

5.3 Mechanical stress due to warping and torsion.

- (a) Crack occurrence ratio will be increased by manual separation.
- (b) Crack occurrence ratio will be increased by tensile force , rather than compressive force.

× :Tensile Stress

○ :Compressive Stress

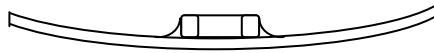
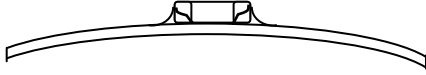

Capacitor Stress Analysis

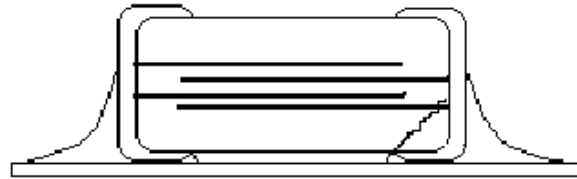
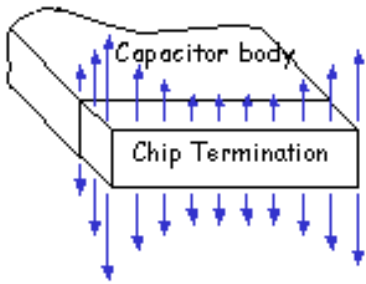

**6. Handling of Loose Chip Capacitor**

6.1 If dropped the chip capacitor may crack.

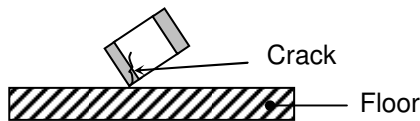

6.2 In piling and stacking of the P.C. boards after mounting for storage or handling, the corner of the P.C. board may hit the chip capacitor mounted on another board to cause crack.

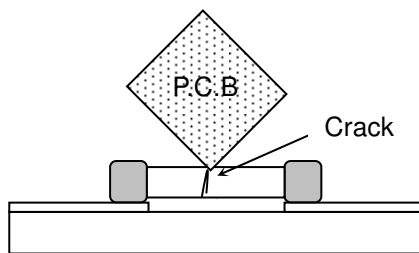

**7. Safekeeping condition and period**

For safekeeping of the products, we recommend to keep the storage temperature between +5 to +40 °C and under humidity of 20 to 75% RH. The shelf life of capacitors is 6 months.