

TACTILE SWITCHES

THE NEXT GENERATION

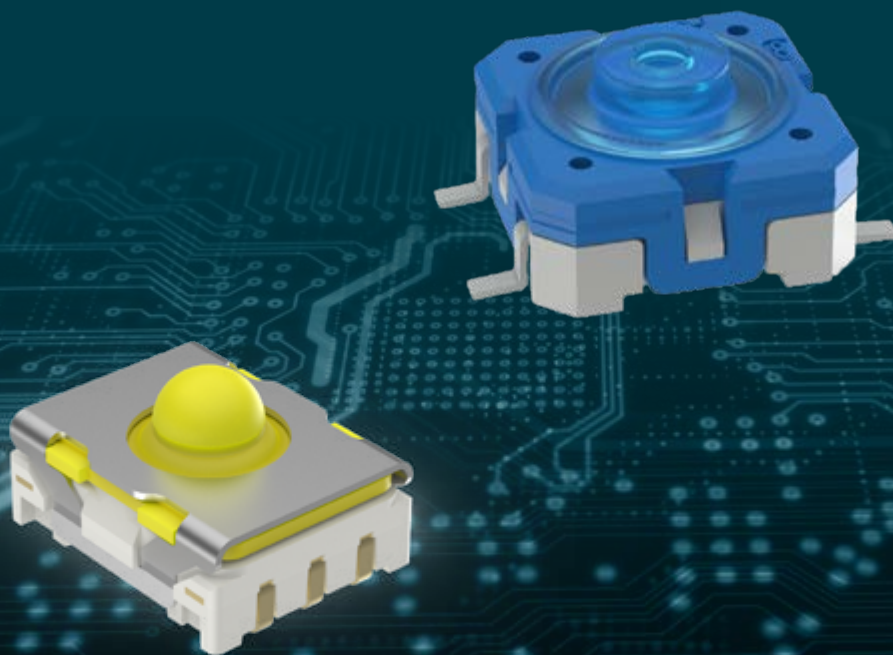

MICON 5

VERSATILE. DURABLE.

Tactile switch with big effect: The tactile switches of the **MICON 5** family convince with an extraordinary tactile feedback. The integrated gold contacts guarantee reliable key operation. Thanks to the increased IP protection class, the **MICON 5 S** (sealed) tactile switches can be used on printed circuit boards that are made robust against environmental influences or contamination by using potting, dip coating or conformal coating. In combination with the extensive range of accessories, the MICON 5 becomes a universal solution for almost all applications. Various lengths, designs and variants with illumination options are available.

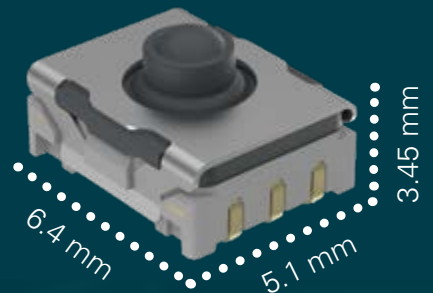

MICON 5 SL

The new **MICON 5 SL** series is the answer to applications in which the tactile switches are actuated frequently. With a operating life of up to ten million actuation cycles, the MICON 5 SL (sealed & extended lifetime) is ideal for use in joysticks or other operating devices that are subject to particularly high stresses. The SL variants are available in SMT and with two different actuation forces.

Variant	Article number	Operating force	Operating life
 SMT	1.14.105.101/0000	2.9 N	10,000,000
	1.14.105.111/0000	5.5 N	





Gold contacts



Unique tactile feedback







Compact dimensions

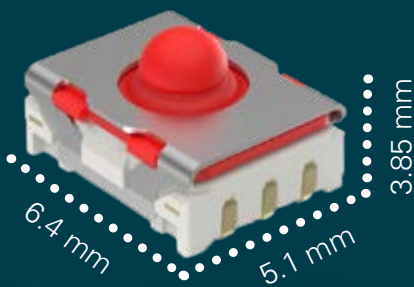

Up to 10 mio. switching cycles

MICON 5



Variant	Article number	Operating force	Operating life
 SMT	1.14.005.201/0000	1.5 N	1,000,000
	1.14.005.101/0000	2.9 N	
	1.14.005.001/0000	3.5 N	
	1.14.005.111/0000	5.5 N	
	1.14.005.011/0000	8 N	
 SMT	1.14.005.103/0000	3 N	1,000,000
	1.14.005.003/0000	3.6 N	
	1.14.005.113/0000	5.5 N	
 THT	1.14.005.106/0000	3 N	250,000
	1.14.005.006/0000	3.6 N	
	1.14.005.116/0000	5.5 N	
	1.14.005.016/0000	8 N	

You can find more information in our eCatalog at ecatalog.rafi-group.com

MICON 5 SAFETY

COMPACT. DUAL CHANNEL. SAFE.

The **MICON 5 SAFETY** not only integrates the outstanding features of the MICON 5 S, such as the extended temperature range and the possibility of potting, dip coating or conformal coating, in the smallest possible space, it also has two isolated normally closed and normally open contacts. With these features it is worldwide unique in this size, because the dimensions and also the compatibility to the MICON accessories program remain unchanged. These features enable a particularly economical and space saving design for applications that are developed according to industry-specific functional safety standards – such as:

IEC 61508	Functional safety
IEC 62061	Safety of machinery
IEC 60601	Medical equipment
ISO 26262	Road vehicles
DIN EN 50128	Railway
DIN EN ISO 13849	Industrial automation
DIN EN ISO 25119	Agriculture and forestry



1 NC + 1 NO



Operating temperature
-40 °C to +125 °C



Unique worldwide



Compact dimensions



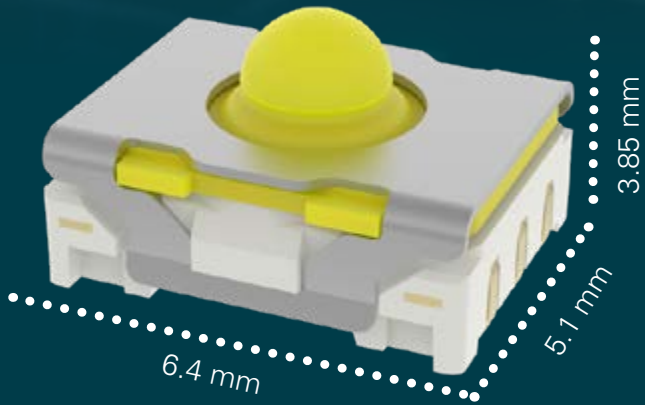

CIRCUIT DIAGRAM



MICON 5 SAFETY

Variant	Article number	Operating force	Operating life
 SMT	1.14.205.101/0000	2.9 N	1,000,000
	1.14.205.111/0000	5.6 N	

You can find more information in our eCatalog at ecatalog.rafi-group.com

RACON ST

VARIABLE. ROBUST.



The **RACON ST** fits into your operating system as if it were tailor-made. The product family offers the right tactile switch for every project: The RACON 8 ST and RACON 12 ST series differ in their dimensions and operating forces. SMT as well as THT versions are available for both.

RACON ST - particularly robust

Like the MICON 5 S, the RACON ST (sealed & extended temperature) is also sealed and can be used on

printed circuit boards, which are made robust against environmental influences or contamination by potting, dip coating or conformal coating. Thanks to its extreme temperature resistance from -40 °C to +125 °C, the RACON ST is ideal for automotive applications or similar outdoor applications. A tight, robust and gold-based contact system makes it additionally resistant and switch-safe. The result: operation is absolutely reliable for at least one million operating cycles.

RACON 8 ST

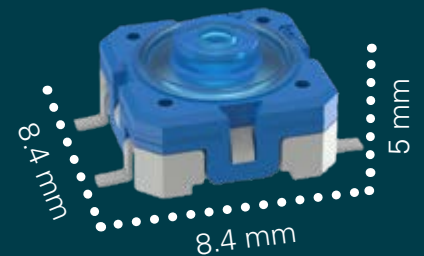

Variant	Article number	Operating force	Operating life
 THT external	1.14.108.501/0000	3.3 N	1,000,000
	1.14.108.601/0000	4.8 N	
	1.14.108.801/0000	6 N	50,000
 THT internal	1.14.108.502/0000	3.3 N	1,000,000
	1.14.108.602/0000	4.8 N	
	1.14.108.802/0000	6 N	50,000
 SMT	1.14.108.503/0000	3.3 N	1,000,000
	1.14.108.603/0000	4.8 N	
	1.14.108.803/0000	6 N	50,000
	1.14.108.903/0000	6.8 N	1,000,000





IP54 and IPX7



**Operating temperature
-40 °C to +125 °C**



**Wide range of
operating forces**



**Robust
contact system**

RACON 12 **ST**

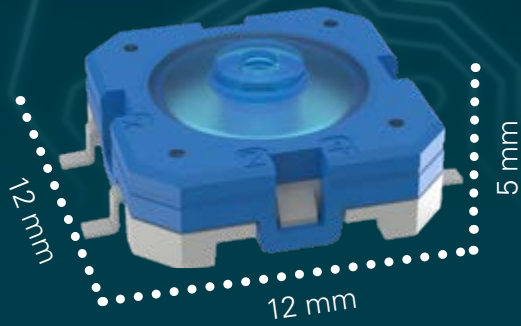

Variant	Article number	Operating force	Operating life	
THT external	1.14.112.601/0000	2.5 N	1,000,000	
	1.14.112.501/0000	3.6 N		
	1.14.112.801/0000	4.7 N		
THT internal	1.14.112.602/0000	2.5 N		
	1.14.112.502/0000	3.6 N		
	1.14.112.802/0000	4.7 N		
	1.14.112.918/0000	6.8 N		
	1.14.112.926/0000	9.7 N		65,000
SMT	1.14.112.603/0000	2.5 N		1,000,000
	1.14.112.503/0000	3.6 N		
	1.14.112.803/0000	4.7 N		
	1.14.112.916/0000	6.8 N		
	1.14.112.920/0000	9.7 N	65,000	
vertical	1.14.112.505/0000	3.6 N	1,000,000	
vertical	1.14.112.927/0000	9.7 N	200,000	

You can find more information in our eCatalog at ecatalog.rafi-group.com

MEDIA ROBUST ELECTRONICS

CONSISTENT. ROBUST. DURABLE.

In order to become robust against environmental influences such as condensation or contamination, there are various ways to protect the printed circuit board. In this context, our customers and also we at RAFI often rely on potting, dip coating or conformal coating of entire circuit board assemblies. There were always challenges with the previous tactile switches, because they were not designed for the application of such circuit board protection methods. We have optimized this and offer a new generation of MICONs and RACONs that are equipped for such applications.

CONFORMAL COATING

In conformal coating, a distinction is made between dip coating and selective coating with a spray head. With selective coating, only critical components and contacts can be painted, thus saving costs by using less material. Painting protects against condensation or contamination and also provides ESD protection. In the case of MICON and RACON, the flexible pressure piece should be left out during coating, as otherwise paint particles can flake off when the button is subsequently actuated.



POTTING



In potting, the printed circuit board is partially or completely filled with a medium and offers not only excellent protection in constant humidity but also mechanical protection in case of vibration and improved heat dissipation. This can significantly extend the lifetime of the electronics. The new generation MICONs and RACONs (sealed) can now be completely enclosed up to the defined potting height without hesitation and continue to function reliably thereafter.



DIP COATING

Dip coating is usually applied in an immersion process in which the assembled circuit board is immersed in a basin. The coating material has the task of penetrating into every corner of the assembly in order to provide the best possible protection for the circuit board. A thin layer of just 400 nm is sufficient here to reliably protect the electronics from malfunctions and moisture. For the tactile switches, on the other hand, it is a great challenge to resist this coating – but MICON as well as RACON are ideally suited for exactly this purpose.



	Conformal coating	Potting	Dip coating
Features	<ul style="list-style-type: none"> • 20-50 µm • transparent • ESD protection • protection against condensation 	<ul style="list-style-type: none"> • from 1 mm • protection against constant humidity • mechanical protection during vibration and improved heat dissipation 	<ul style="list-style-type: none"> • 400 nm • transparent • protection against condensation
Protection level			
Process	selective and dip coating	mold filling	dipping
Costs	€€	€€€	€
Flexibility with change	flexible	inflexible	flexible
Repairability	✗	✗	✓

QUALITY AND APPLICATION

RELIABLE. TRACEABLE. UNIVERSAL.



CONTINUOUS MONITORING

We leave nothing to chance in the production of our tactile switches. MICON and RACON are manufactured in high-performance automatic machines at our location in Germany. Continuous monitoring of the process steps via camera systems guarantees compliance with our quality standards.



100 % INSPECTION

Our tactile switches are characterized by their tactility. Here we leave nothing to chance. The force-travel characteristic is tested for each tactile switch, thus ensuring consistent tactility and quality.



TRACEABILITY

For traceability purposes, each tactile switch is laser-marked after passing the 100 % test. In this way, it is possible to trace when each tactile switch was produced and which individual parts were used.



PACKAGING

Depending on the variant (THT or SMT), we pack the tactile switch in rails or blisters. This enables us to feed the tactile switch quickly and safely for further processing in automatic electronic assembly machines.

OPERATING WORLDWIDE

Hardly visible, but strongly noticeable. Our tactile switches have already been in reliable use for many years. Numerous applications demonstrate their versatility – and the success story continues. Every day, new projects are added in which MICON and RACON have been able to convince.



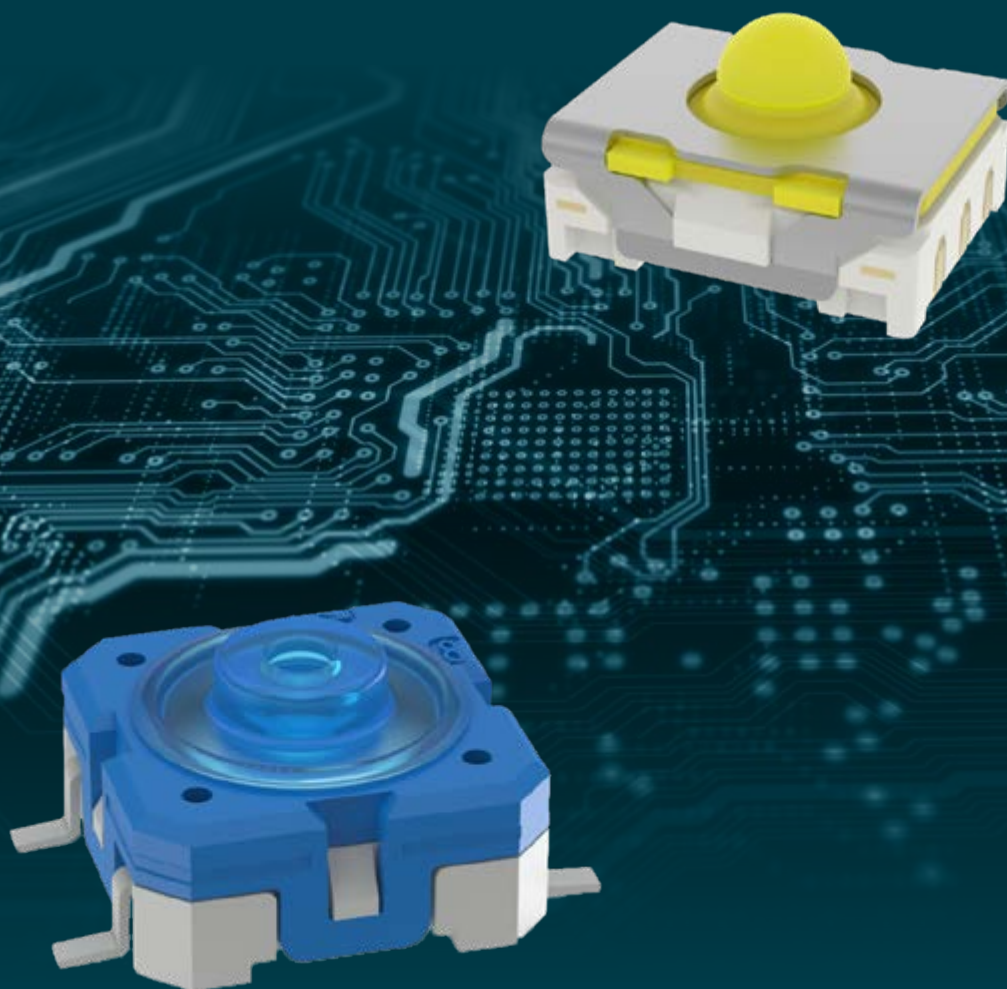

The information in this brochure contains general descriptions and performance characteristics which may not apply exactly in the specific application and/or which can change due to further development of the products. The technical data, images and other details of our products are merely the results of individual technical tests. These and other performance characteristics are only binding when they are expressly agreed upon conclusion of the contract.

Otherwise, the following applies:

We reserve the right to change delivery options and technical details. Products are similar to the illustrations and other forms of representation.

All product designations can be brands or product names of the RAFI Group or other suppliers whose use by third parties for their own purposes may violate the owner's rights.

RAFI GmbH & Co. KG

A RAFI Group company

Ravensburger Str. 128–134, 88276 Berg, Germany

P +49 751 89-0, F +49 751 89-1300

rafi-group.com, info.headquarters@rafi-group.com

RAFI