



# Distinctive Characteristics

Antirootation design, standard on noncylindrical levers, mates toggle and bushing; bottom of toggle has two flattened sides which fit into a complementary opening inside bushing.

Antijamming design protects contacts from damage due to excessive downward force on actuator.

High torque bushing construction prevents rotation or separation from frame during installation.

High insulating barriers increase isolation of circuits in multiple devices and provide added protection to contact points.

Molded diallyl phthalate case has a UL flammability rating of 94V-0.

Epoxy sealed terminals prevent entry of solder flux and other contaminants.

Prominent external insulating barriers increase insulation resistance and dielectric strength.

Interlocked actuator block, lever, and interior guide prevent switch failure due to biased lever movement.

Clinching of frame to case well above base and terminals provides 1,500V dielectric strength.

Special silver alloy contacts with excellent wear resistance and arc resistance maintain high contact stability and long life.

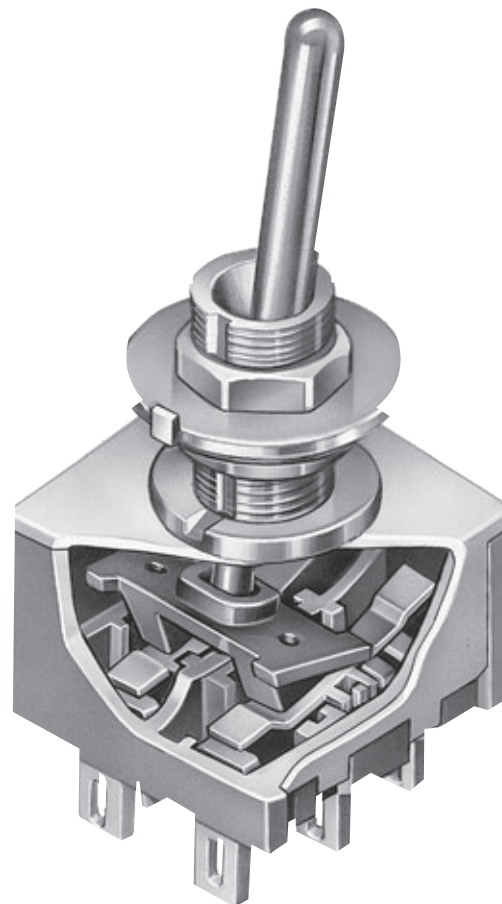

Actual Size

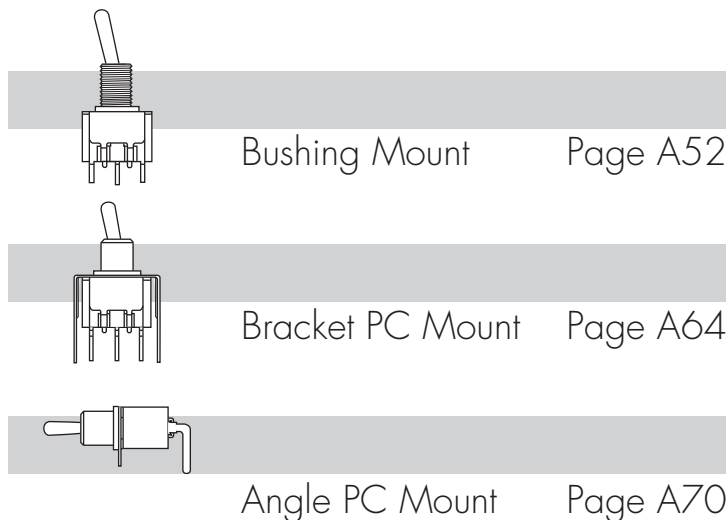
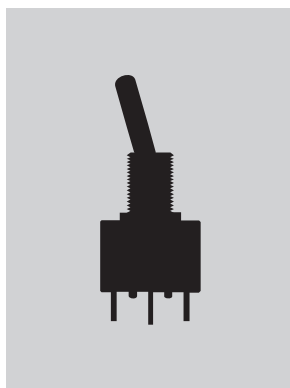

- A Toggles
- Rockers
- Pushbuttons
- Illuminated PB
- Programmable
- Keylocks
- Rotaries
- Slides
- Tactiles
- Tilt
- Touch
- Indicators
- Accessories
- Supplement

Toggles  
A

Rockers

Pushbuttons

Programmable Illuminated PB

Keylocks

Rotaries

Slides

Tactiles

Tilt

Touch

Indicators

Accessories

Supplement



Poles	
1	SPST SPDT
2	DPST DPDT SP3T
3	3PDT
4	4PDT DP3T

Circuits			
* 1	ON	NONE	OFF
2	ON	NONE	ON
3	ON	OFF	ON
5	ON	NONE	(ON)
8	(ON)	OFF	(ON)
9	ON	OFF	(ON)
** 4	ON	ON	ON
** 6	(ON)	ON	(ON)
** 7	ON	ON	(ON)

NONE = No Position

( ) = Momentary

\* ON-NONE-OFF circuit available in 1- and 2-pole only.

\*\* 3-ON circuits

Small Toggles	
S	.413" (10.5mm) Bat
S2	.200" (5.08mm) Bat
S3	.256" (6.5mm) Bat
E	.450" (11.4mm) Flatted
*E2	.256" (6.5mm) Flatted
*Available on 1- and 2-pole only	

Large Toggles	
B	.453" (11.5mm) Large Bat
B2	.689" (17.5mm) Large Bat

Locking Lever	
L	.201" (5.1mm) Dia. Locking Lever

Small Bushings	
*S1	.350" (8.9mm) Threaded with Keyway
**S4	6mm .350" (8.9mm) Threaded with Keyway
***S2	.350" (8.9mm) Smooth with Keyway
****D3	.350" (8.9mm) Threaded Splashproof with D Flat (combines only with S, S2 & S3)
**D8	6mm .350" (8.9mm) Threaded Splashproof with D Flat (combines only with S, S2 & S3)
* 01 & 06 Terminals Only	
** 01 & 03 Terminals Only	
*** 03 Terminal Only	
**** 01 Terminal Only	

Large Bushings	
**B1	Large .472" (12.0mm) Threaded with Keyway
****B3	Large .472" (12.0mm) Threaded Splashproof with D Flat
** 01 & 03 Terminals Only	
**** 01 Terminal Only	

Bushings For Locking Levers	
*L1	.291" (7.4mm) Threaded with Keyway for Lever Lock
**L4	6mm .291" (7.4mm) Threaded with Keyway for Lever Lock
***L2	Smooth with Keyway for Lever Lock
****L3	.295" (7.5mm) Threaded Splashproof with D Flat for Lever Lock
* 01 & 06 Terminals Only	
** 01 & 03 Terminals Only	
*** 03 Terminal Only	
**** 01 Terminal Only	

## ORDERING EXAMPLE

Contact Materials & Ratings	
<b>W</b>	Silver; Rated 2 ~ 6A @ 125V AC & 2 ~ 3A @ 250V AC
<b>G</b>	Gold; Rated 0.4VA max @ 28V AC/DC max

Terminals	
<b>*01</b>	Solder Lug
<b>**03</b>	.250" (6.35mm) Straight PC
<b>***06</b>	.750" (19.05mm) Wirewrap

\* Combines with Threaded Bushings Only  
 \*\* Combines with S4, S2, D8, L4 & L2 Bushings Only  
 \*\*\* Combines with S1 Bushing Only

Optional Caps	
<b>For Small Bat Toggles</b>	
<b>B</b>	For S Bat Toggle
<b>C</b>	Conical Cap for S Bat Toggle
<b>For Large Bat Toggles</b>	
<b>R</b>	For B Toggle
<b>V</b>	For B2 Toggle

Cap for Locking Lever	
<b>No Code</b>	Nickel Plated Supplied with Switch
<b>A</b>	Black
<b>C</b>	Red
<b>G</b>	Blue







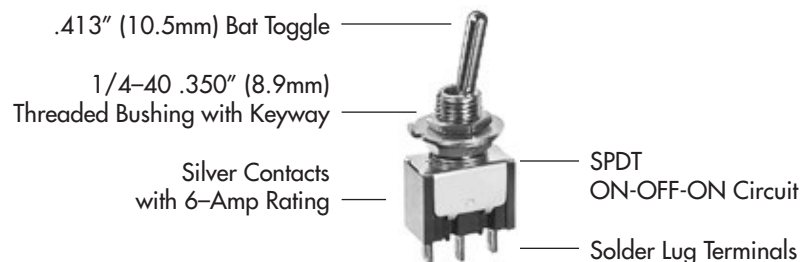

Cap Colors	
<b>A</b>	Black
<b>B</b>	White
<b>C</b>	Red
<b>E</b>	Yellow
<b>F</b>	Green
<b>G</b>	Blue

### DESCRIPTION FOR TYPICAL ORDERING EXAMPLE

### MN13SS1W01

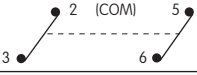
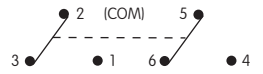
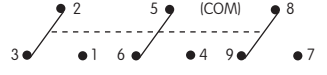
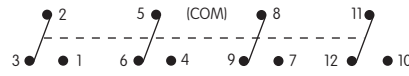

## POLES & CIRCUITS

		Toggle Position			Connected Terminals			Throw & Schematics	
		NONE = No Position ( ) = Momentary							
Pole	Model	Down	Center	Up	Down	Center	Up	Note: Terminal numbers are not actually on the switch.	
									
SP	MN11	ON	NONE	OFF	2-3	OPEN	OPEN	SPST	
	MN12	ON	NONE	ON	2-3	OPEN	2-1	SPDT	
	MN13	ON	OFF	ON					
	MN15	ON	NONE	(ON)					
	MN18	(ON)	OFF	(ON)					
MN19	ON	OFF	(ON)						
DP	MN21	ON	NONE	OFF	2-3 5-6	OPEN	OPEN	DPST	
	MN22	ON	NONE	ON	2-3 5-6	OPEN	2-1 5-4	DPDT	
	MN23	ON	OFF	ON					
	MN25	ON	NONE	(ON)					
	MN28	(ON)	OFF	(ON)					
MN29	ON	OFF	(ON)						
3P	MN32	ON	NONE	ON	2-3 5-6 8-9	OPEN	2-1 5-4 8-7	3PDT	
	MN33	ON	OFF	ON					
	MN35	ON	NONE	(ON)					
	MN38	(ON)	OFF	(ON)					
	MN39	ON	OFF	(ON)					
4P	MN42	ON	NONE	ON	2-3 5-6 8-9 11-12	OPEN	2-1 5-4 8-7 11-10	4PDT	
	MN43	ON	OFF	ON					
	MN45	ON	NONE	(ON)					
	MN48	(ON)	OFF	(ON)					
	MN49	ON	OFF	(ON)					

### For 3 Throw (3-On)

### Connected Terminals & Schematic

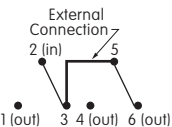
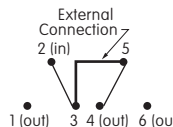
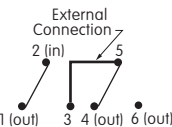
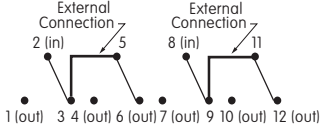
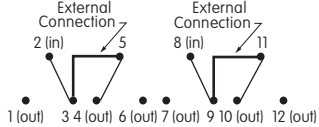
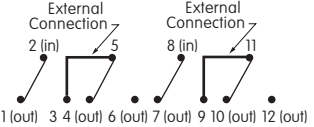
Pole	Model	Down	Center	Up	Down	Center	Up
SP	MN24 MN26 MN27	ON	ON	ON			
		(ON)	ON	(ON)	2-3 5-6	2-3 5-4	2-1 5-4
		ON	ON	(ON)			
DP	MN44 MN46 MN47	ON	ON	ON			
		(ON)	ON	(ON)	2-3 5-6 8-9 11-12	2-3 5-4 8-9 11-10	2-1 5-4 8-7 11-10
		ON	ON	(ON)			

The SP3T model utilizes a double pole base.

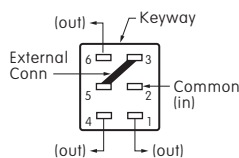

External connection must be made during field installation.

The DP3T model utilizes a four pole base.

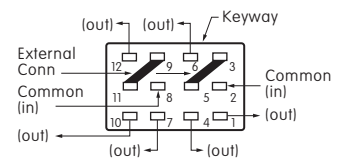

External connection must be made during field installation.

## SMALL TOGGLES

A Toggles

### Important:

Toggle length changes based on bushing selected. All illustrations are shown with .350" long bushing. When using a .280" long bushing, toggle length increases .070".

**S** .413" (10.5mm) Bat

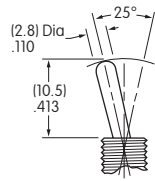

**S2** .200" (5.08mm) Bat

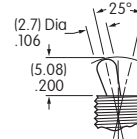

**S3** .256" (6.5mm) Bat

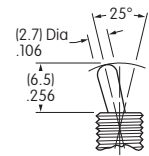

Standard Material & Finish: Brass with Bright Chrome  
Contact factory for optional finishes.

**E** .450" (11.4mm) Flatted

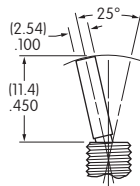
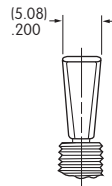

**E2** .256" (6.5mm) Flatted

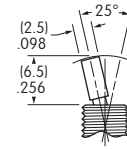
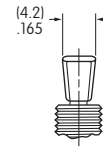

## SMALL BUSHINGS

**S1** 1/4-40 .350" (8.9mm) Threaded with Keyway

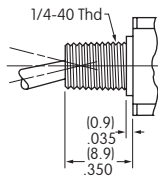
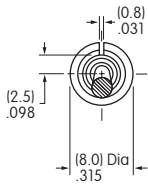

**S4** 6mm/.350" (8.9mm) Threaded with Keyway

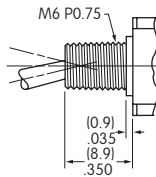
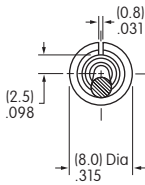

**S2** .350" (8.9mm) Smooth with Keyway

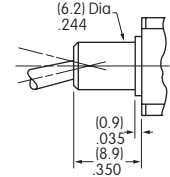
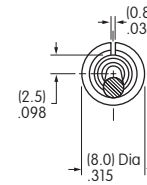

Maximum Panel Thickness with Standard Hardware: .102" (2.6mm)

Maximum Panel Thickness with Standard Hardware: .102" (2.6mm)

**D3** 1/4-40 .350" (8.9mm) Threaded Splashproof with D Flat

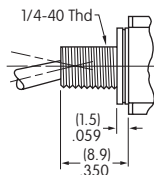
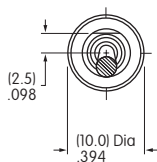

**D8** 6mm/.350" (8.9mm) Threaded Splashproof with D Flat

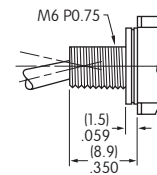
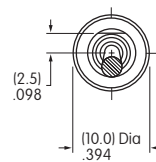

D3 combines only with S, S2 & S3 toggles. Maximum Panel Thickness with Standard Hardware: .193" (4.9mm)

D8 combines only with S, S2 & S3 toggles. Maximum Panel Thickness with Standard Hardware: .193" (4.9mm)

### Standard Hardware Supplied for Small Bushings

Bushing Codes		S1/S4	D3/D8	L1/L4	L3
Hardware and Quantity	Hex Nut	2	1	2	1
	Locking Ring	1	0	1	0
	Lockwasher	1	0	1	0
	O-ring	0	1	0	1

Rockers

Pushbuttons

Illuminated PB

Programmable

Keylocks

Rotaries

Slides

Tactiles

Tilt

Touch

Indicators

Accessories

Supplement

Toggles **A**

For S1, S2 Bushing with Keyway & for L1 Bushing

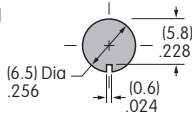

For S1 Bushing with Locking Ring & for L1 Bushing

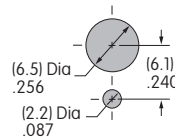

For S4 Bushing with Keyway & for L4 Bushing

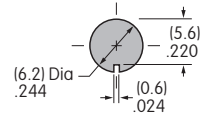

For S4 Bushing with Locking Ring & for L4 Bushing

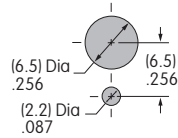

For D3 or D8 Bushing with D Flat & for L3 Bushing

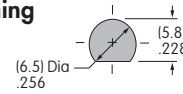

### LARGE TOGGLES

**Toggle & Bushing Combinations:** These toggles combine with the 12mm bushings B1 & B3.

**B** .453" (11.5mm) Large Bar

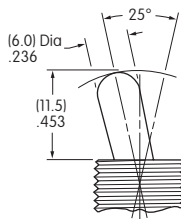

**B2** .689" (17.5mm) Large Bar

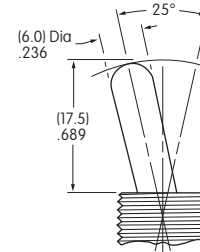

**Standard Material & Finish:** Brass with Bright Chrome  
Optional Finishes: Contact factory for satin chrome or black.

### LARGE BUSHINGS

**B1** Large .472" (12.0mm) Threaded with Keyway

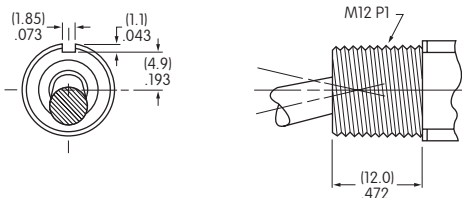

Maximum Panel Thickness with Standard Hardware: .216" (5.5mm)

**B3** Large .472" (12.0mm) Threaded Splashproof with D Flat

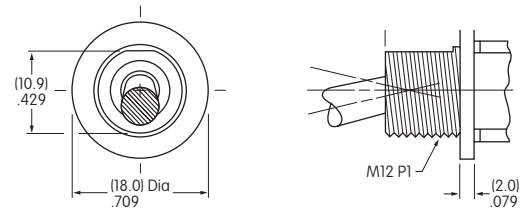

Maximum Panel Thickness with Standard Hardware: .256" (6.5mm)

**Standard Hardware for B1:**  
1 hex face nut AT503M, 1 locking ring AT506M, 1 lockwasher AT508, and 1 hex backup nut AT527M

**Standard Hardware for B3:**  
1 hex face nut AT503M and 1 o-ring AT401P

### Panel Cutouts

For B1 Bushing with Keyway

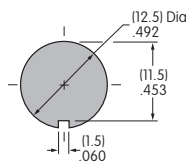

For B1 Bushing with Locking Ring

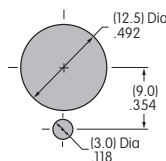

For B3 Bushing with D Flat

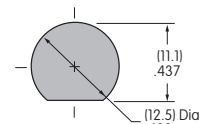

Toggles  
Rockers  
Pushbuttons  
Illuminated PB  
Programmable  
Keylocks  
Rotaries  
Slides  
Tactiles  
Tilt  
Touch  
Indicators  
Accessories  
Supplement



## LOCKING LEVER & BUSHINGS

**LL1** 1/4-40 .291" (7.4mm)  
Threaded with Keyway

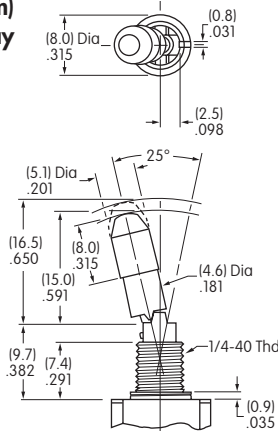

**LL4** 6mm/.291" (7.4mm)  
Threaded with Keyway

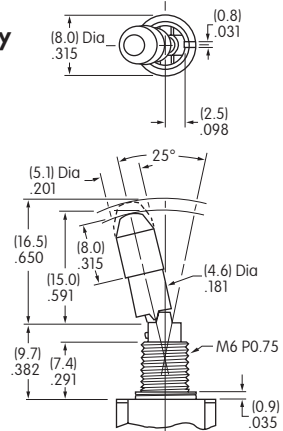

Maximum Panel Thickness with Standard Hardware: .047" (1.2mm)  
Standard Hardware for L1 & L4: 2 hex nuts AT513H or AT513M,  
1 locking ring AT507H or AT507M, and 1 lockwasher AT509

**LL2** Smooth with Keyway

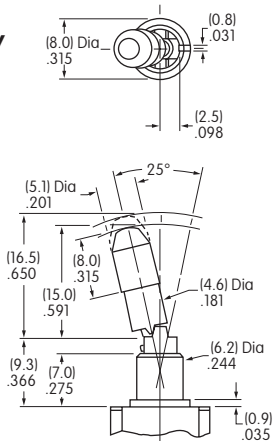

**LL3** 1/4-40 .295" (7.5mm)  
Threaded Splashproof  
with D Flat

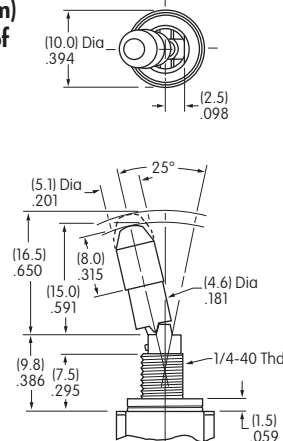

Maximum Panel Thickness with Standard Hardware: .047" (1.2mm)  
Standard Hardware: 1 hex nut AT513H and 1 o-ring AT516

Lever Material & Finish: Brass with Chrome Plating

on-none-on

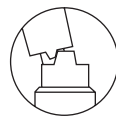

2 positions lock

on-none-(on)



1 position locks

on-off-(on)  
on-on-(on)



2 positions lock

on-off-on  
on-on-on

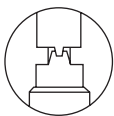

3 positions lock

(on)-off-(on)  
(on)-on-(on)

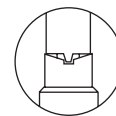

1 position locks

Locking  
Mechanism

**No Code**

Supplied with Cap AT427

Cap Material:  
Brass with Nickel Plating

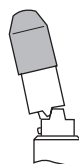

Lever

Color Codes for Optional Anodized Aluminum Caps

**A**

Black

**C**

Red

**G**

Blue



## CONTACT MATERIALS & RATINGS

**W**

**Silver  
Power Levels**

**MN11, MN12, MN21, MN22:** 6A @ 125V AC, 3A @ 250V AC, 4A @ 30V DC  
**MN13, MN15, MN18, MN19, MN23, MN25:** 6A @ 125V AC, 3A @ 250V AC, 3A @ 30V DC  
**MN28, MN29:** 4A @ 125V AC, 3A @ 250V AC, 3A @ 30V DC  
**MN32, MN42:** 4A @ 125V AC, 2A @ 250V AC, 3A @ 30V DC  
**MN33, MN35, MN38, MN39:** 4A @ 125V AC, 2A @ 250V AC, 2A @ 30V DC  
**MN43, MN45, MN48, MN49:** 4A @ 125V AC, 2A @ 250V AC, 2A @ 30V DC  
**MN24, MN26, MN27, MN44, MN46, MN47:** 3A @ 125V AC, 2A @ 250V AC, 2A @ 30V DC

**G**

**Gold**

**Logic Level**

**0.4VA maximum @ 28V AC/DC maximum**

Note: See Supplement section to find complete explanation of operating range.

**Gold over Silver**

**Power Level  
or Logic Level**

**See above for ratings**

Note: Gold over silver is available as a custom option. This dual rated option is suitable when two or more identical switches are used in logic and in power circuits within the same application. See Supplement section to find complete explanation of dual rating and operating range.

## TERMINALS

**01**

**Solder Lug**

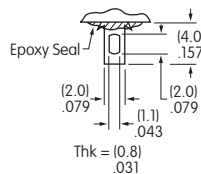

**03**

**.250" (6.35mm)  
Straight PC**

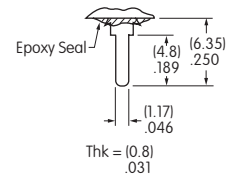

**Footprints for  
Straight PC  
Terminals**

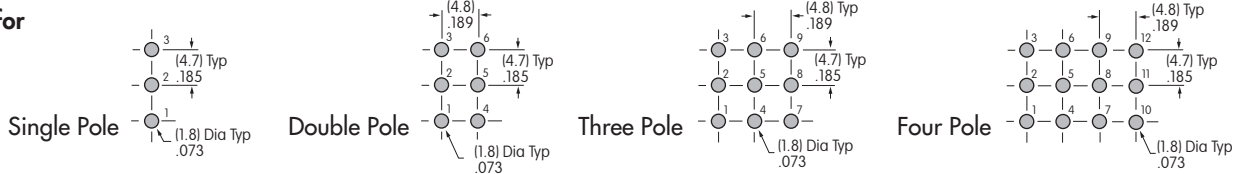

**06**

**.750" (19.05mm)  
Wirewrap or Extended PC**

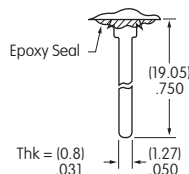

If using as extended PC terminal, refer to the footprints above.

## OPTIONAL CAPS & CAP COLORS

**B**

**\* AT415 Lever Cap  
for S Bat Toggle**

Material: Polyethylene

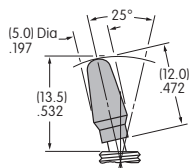

**C**

**\* AT444 Conical Cap  
for S Bat Toggle**

Material: Polyethylene

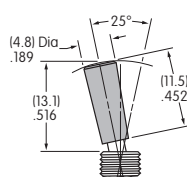

**R**

**AT434 Lever Cap  
for B Toggle**

Material: Polyvinyl Chloride

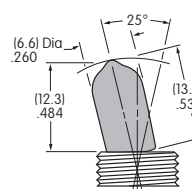

**V**

**AT406 Lever Cap  
for B2 Toggle**

Material: Polyvinyl Chloride

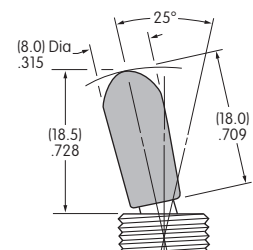

\* AT415 and AT444 for use with S toggles only, not S2 or S3 toggles.

**Cap Colors  
Available:**

**A**

Black

**B**

White

**C**

Red

**E**

Yellow

**F**

Green

**G**

Blue

## TYPICAL SWITCH DIMENSIONS

### Single Pole

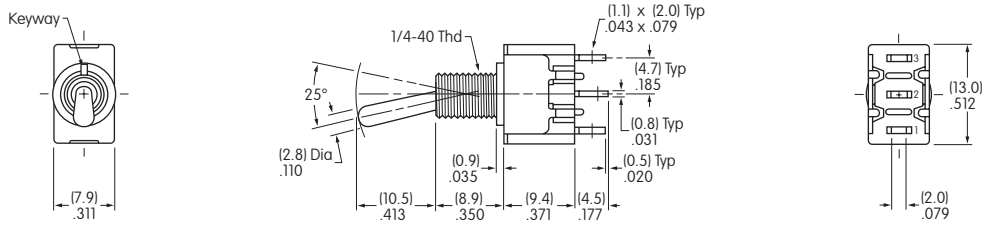

MN11 model does not have terminal 1.

### Solder Lug



**MN12SS1W01**

### Double Pole

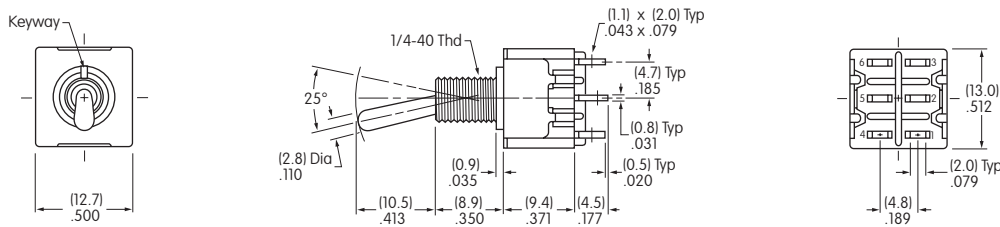

MN21 model does not have terminals 1 & 4.

### Solder Lug



**MN22SS1W01**

### Three Pole

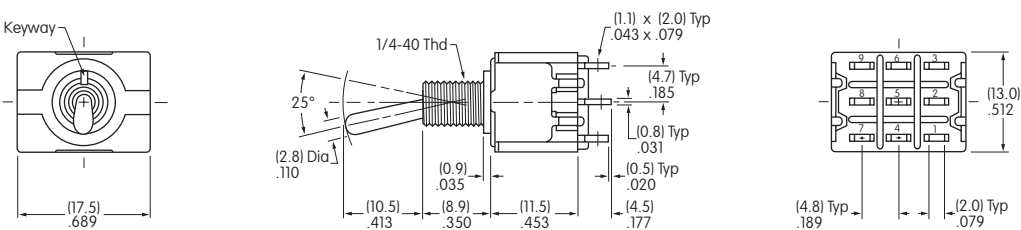

**MN32SS1W01**

### Four Pole

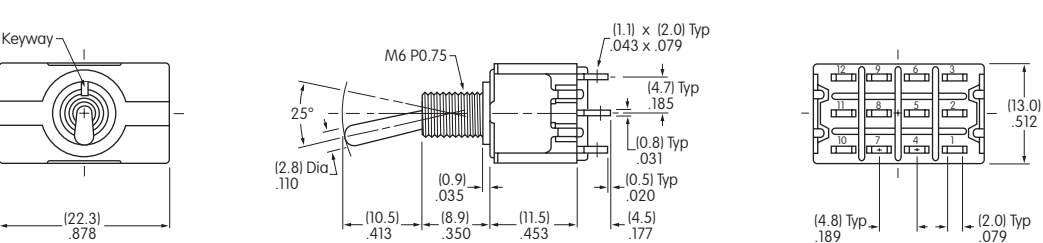

**MN42SS4W01**

A  
Toggles

Rockers

Pushbuttons

Illuminated PB

Programmable

Keylocks

Rotaries

Slides

Tactiles

Tilt

Touch

Indicators

Accessories

Supplement

## STANDARD HARDWARE FOR SMALL & LARGE BUSHINGS

**AT513H for Inch**  
**AT513M for Metric**  
**Hex Nut**  
Brass/Nickel

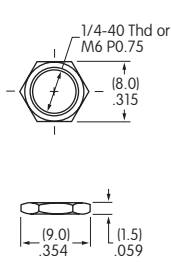

**AT507H for Inch**  
**Locking Ring**  
Steel with Zinc/Chromate

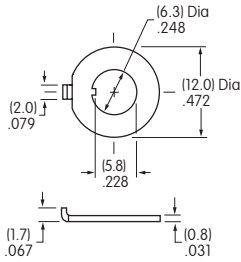

**AT507M for Metric**  
**Locking Ring**  
Steel with Zinc/Chromate

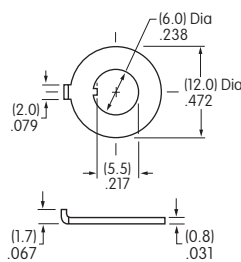

**AT509**  
**Lockwasher**  
Steel with Zinc/Chromate  
(not supplied with splashproof models)

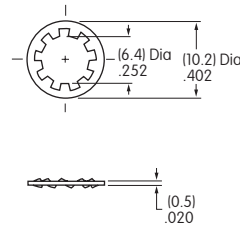

**AT516**  
**O-ring for Splashproof Models**  
Nitrile Butadiene Rubber

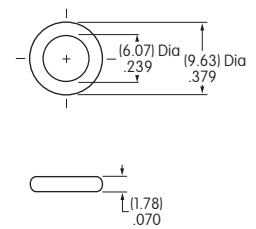

**AT503M**  
**Hex Face Nut**  
Brass/Chrome

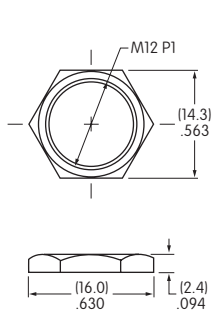

**AT506M**  
**Locking Ring**  
Steel with Zinc/Chromate

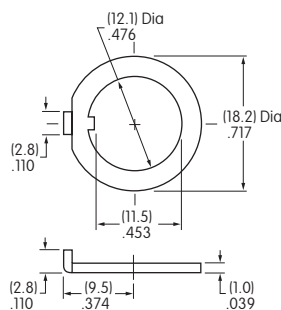

**AT508**  
**Lockwasher**  
Steel with Zinc/Chromate  
(not supplied with splashproof models)

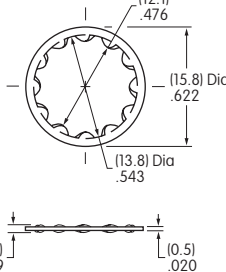

**AT527M**  
**Hex Nut**  
Steel with Nickel Plating

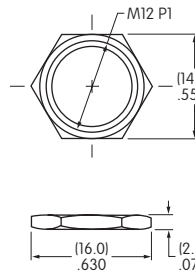

**AT401P**  
**O-ring for Splashproof Models**  
Nitrile butadiene rubber

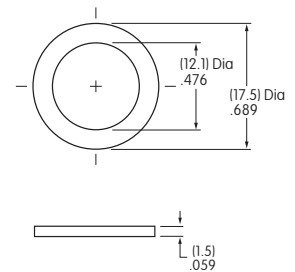

## OPTIONAL SPLASHPROOF BOOTS

Various optional nuts and ON-OFF plates are available; dimensions are shown in the Accessories & Hardware section.

**AT428 (M-metric H-Inch)**  
**.445" (11.3mm)**  
**Boot for S Toggle**  
Silicon Rubber

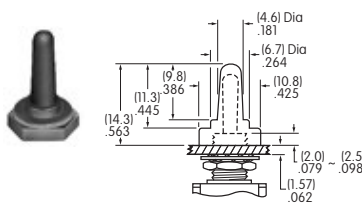

**AT402**  
**.760" (19.3mm)**  
**Boot for B2 Toggle**  
Silicon Rubber

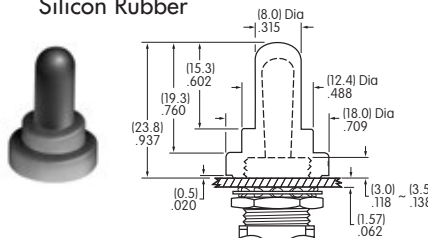

**AT402S**  
**.567" (14.4mm)**  
**Boot for B Toggle**  
Silicon Rubber

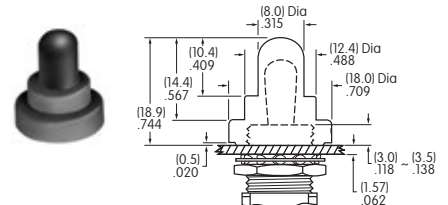

**AT401A/H/S**  
**.461" (11.7mm)**  
**Boot, Nut and O-ring for B2 Toggle**  
More details in Accessories section

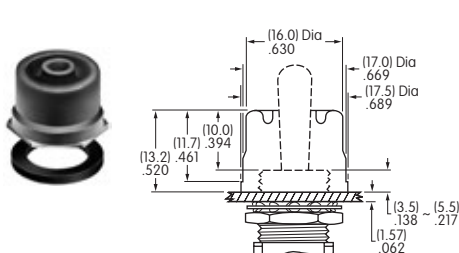

**AT4181**  
**.732" (18.6mm)**  
**Boot, Nut and O-ring for B2 Toggle**  
More details in Accessories section

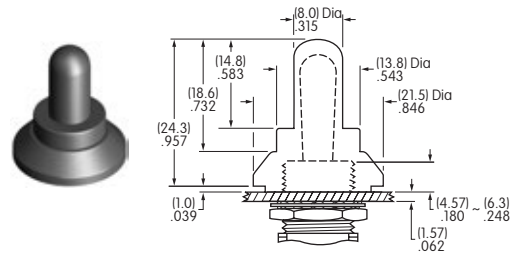



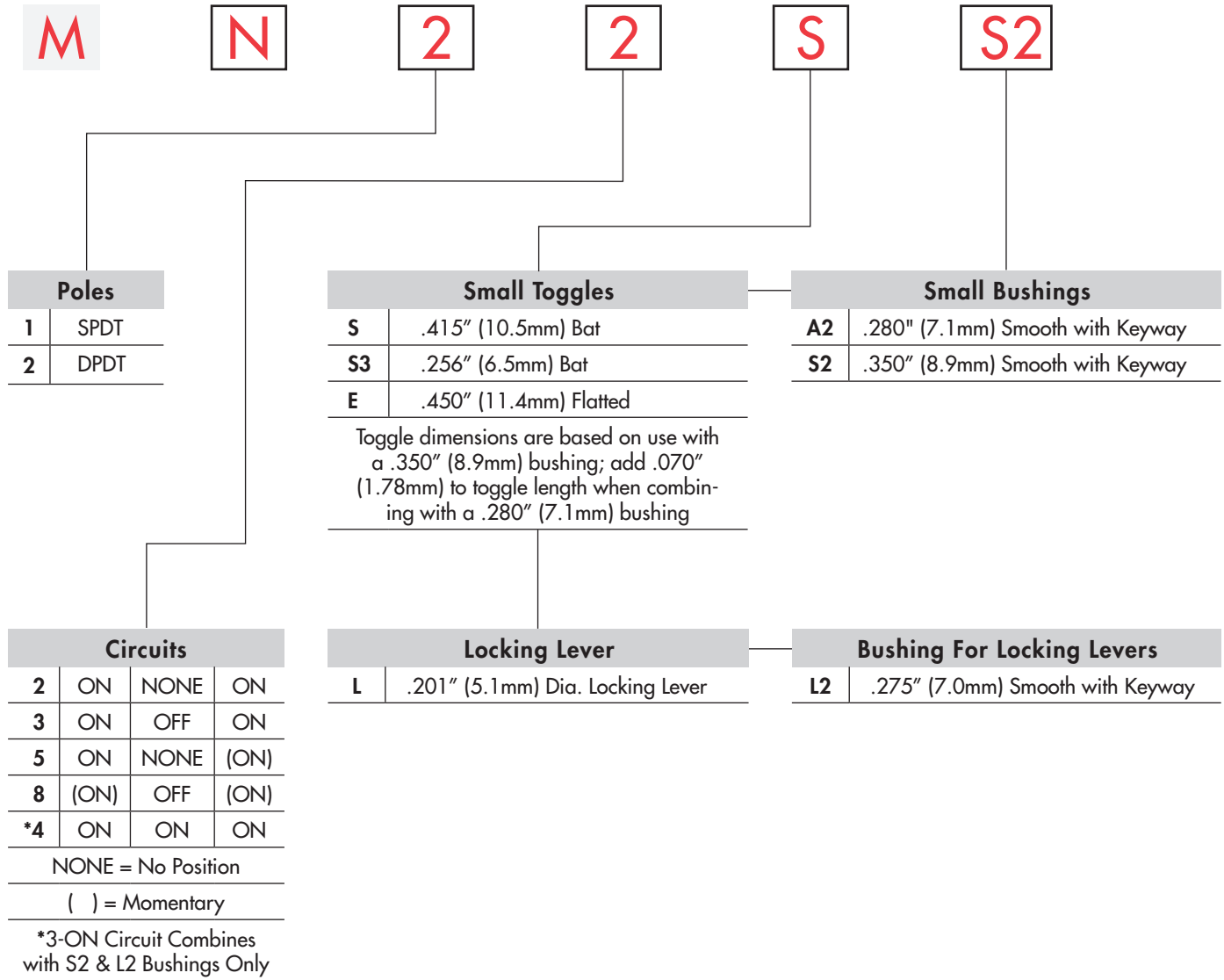

## ORDERING EXAMPLE

Contact Materials & Ratings		Optional Caps		Cap Colors	
<b>W</b>	Silver; Rated 2 ~ 6A @ 125V AC & 2 ~ 3A @ 250V AC	<b>B</b>	For S Bat Toggle	<b>A</b>	Black
<b>G</b>	Gold; Rated 0.4VA max @ 28V AC/DC max	<b>C</b>	Conical Cap for S Bat Toggle	<b>B</b>	White
				<b>C</b>	Red
				<b>E</b>	Yellow
				<b>F</b>	Green
				<b>G</b>	Blue

Cap for Locking Lever	
<b>No Code</b>	Nickel Plated Supplied with Switch
<b>A</b>	Black
<b>C</b>	Red
<b>G</b>	Blue





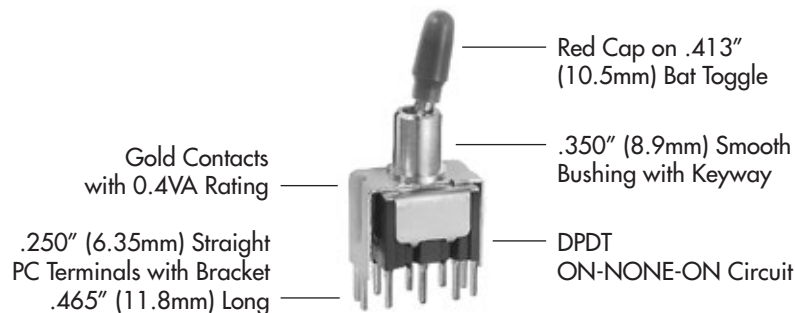

Terminals	
<b>13</b>	.250" (6.35mm) Straight PC with .465" (11.8mm) Bracket

### DESCRIPTION FOR TYPICAL ORDERING EXAMPLE

**MN22SS2G13-BC**

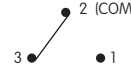
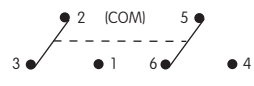

## POLES & CIRCUITS

		Toggle Position			Connected Terminals			Throw & Schematics
		NONE = No Position ( ) = Momentary						
Pole	Model	Down 	Center 	Up 	Down 	Center 	Up 	Note: Terminal numbers are not actually on the switch.
SP	MN12 MN13 MN15 MN18	ON ON ON (ON)	NONE OFF NONE OFF	ON ON (ON) (ON)	2-3	OPEN	2-1	SPDT 
DP	MN22 MN23 MN25 MN28	ON ON ON (ON)	NONE OFF NONE OFF	ON ON (ON) (ON)	2-3 5-6	OPEN	2-1 5-4	DPDT 

### For 3 Throw (3-On)

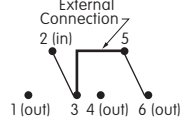
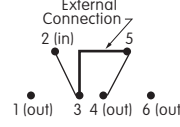
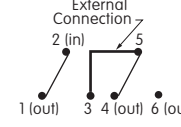
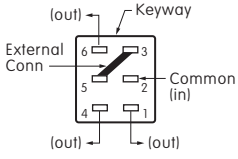
Pole	Model	Connected Terminals & Schematics			External Connection
		Down	Center	Up	
SP	MN24	ON  2-3 5-6	ON  2-3 5-4	ON  2-1 5-4	<p>The SP3T model utilizes a double pole base.</p> <p>External connection must be made during field installation.</p> 

## SMALL TOGGLES

### Important:

Toggle length changes based on bushing selected. All illustrations are shown with .350" (8.9mm) long bushing. When using a .280" (7.1mm) long bushing, toggle length increases .070" (1.78mm).

### Standard Material & Finish:

Brass with Bright Chrome  
Contact factory for optional finishes.

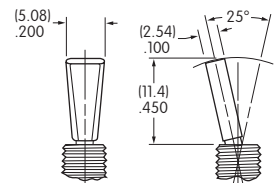
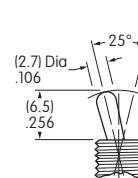
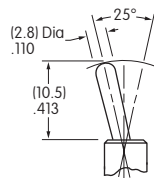
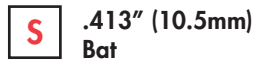

## SMALL BUSHINGS

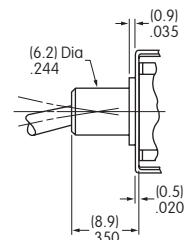
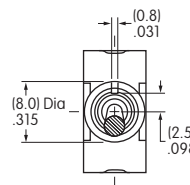
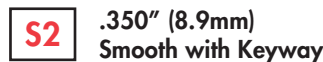
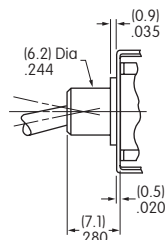
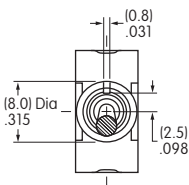
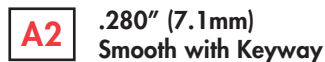

When using this bushing, toggle length is increased by .070" (1.78mm).

Toggles  
 Rockers  
 Pushbuttons  
 Illuminated PB  
 Programmable  
 Keylocks  
 Rotaries  
 Slides  
 Tactiles  
 Tilt  
 Touch  
 Indicators  
 Accessories  
 Supplement



For A2 and S2 Bushings with Keyway

### Panel Cutout

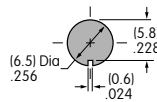

**LL2** Smooth with Keyway

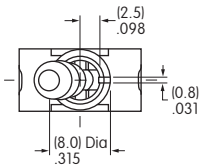

### Locking Mechanism

on-none-on



2 positions lock

on-none-(on)



1 position locks

on-off-on

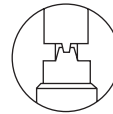

3 positions lock

(on)-off-(on)

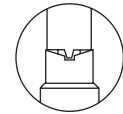

1 position locks

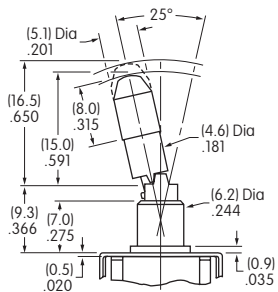

**No Code**

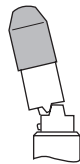

### Cap for Locking Lever

Supplied with Cap AT427  
Material & Finish:

Brass with Nickel Plating

### Lever Material & Finish:

Brass with Chrome Plating

### Color Codes for Optional Anodized Aluminum Caps

**A** Black

**C** Red

**G** Blue

## CONTACT MATERIALS & RATINGS

**W** Silver Power Levels

**MN12, MN22:** 6A @ 125V AC, 3A @ 250V AC, 4A @ 30V DC

**MN13, MN15, MN18, MN23, MN25:** 6A @ 125V AC, 3A @ 250V AC, 3A @ 30V DC

**MN28:** 4A @ 125V AC, 3A @ 250V AC, 3A @ 30V DC

**MN24:** 2A @ 125V AC, 2A @ 250V AC, 2A @ 30V DC

**G** Gold

Logic Level

0.4VA maximum @ 28V AC/DC maximum

Note: See Supplement section to find complete explanation of operating range.

Gold over Silver

Power Level or Logic Level

See above for each rating

Note: This dual rated toggle is available as a custom option and suitable when two or more identical switches are used in logic and in power circuits within the same application. See Supplement section to find complete explanation of dual rating and operating range.

## TERMINALS

### Straight PC Mount with Bracket

**13** .250" (6.35mm) Terminal with .465" (11.8mm) Bracket

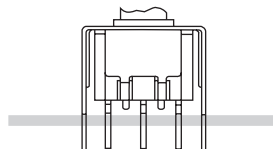

PCB footprints are on the following Typical Switch Dimension page.

### OPTIONAL CAPS & CAP COLORS

**B** \* AT415  
for S Bat Toggle

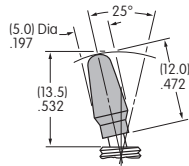

Material:  
Polyethylene

**C** \* AT444  
Conical Cap for  
S Bat Toggle

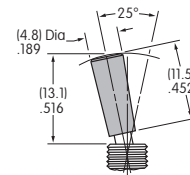

Material:  
Polyethylene

\* AT415 and AT444 for use with S toggles only, not S3 toggles.

Cap Colors  
Available:

**A**

Black

**B**

White

**C**

Red

**E**

Yellow

**F**

Green

**G**

Blue

### TYPICAL SWITCH DIMENSIONS

#### Straight PC • Bracket

**MN12S3A2G13**

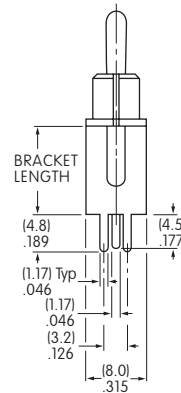
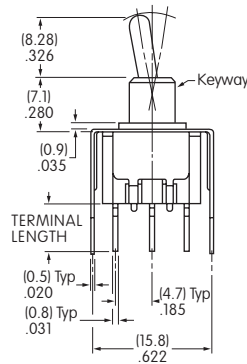

Single  
Pole

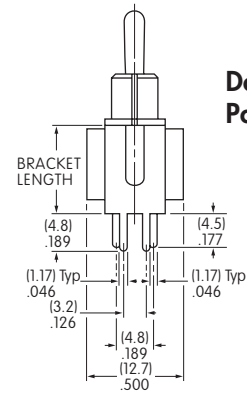

Double  
Pole

Terminal Code:	Terminal Length:	Bracket Length:
<b>13</b>	.250" (6.35mm)	.465" (11.8mm)

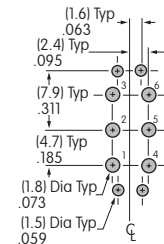
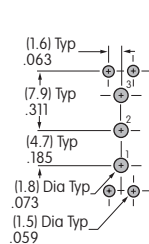



Toggles  
A

Rockers

Pushbuttons

Illuminated PB

Programmable PB

Keylocks

Rotaries

Slides

Tactiles

Tilt

Touch

Indicators

Accessories

Supplement

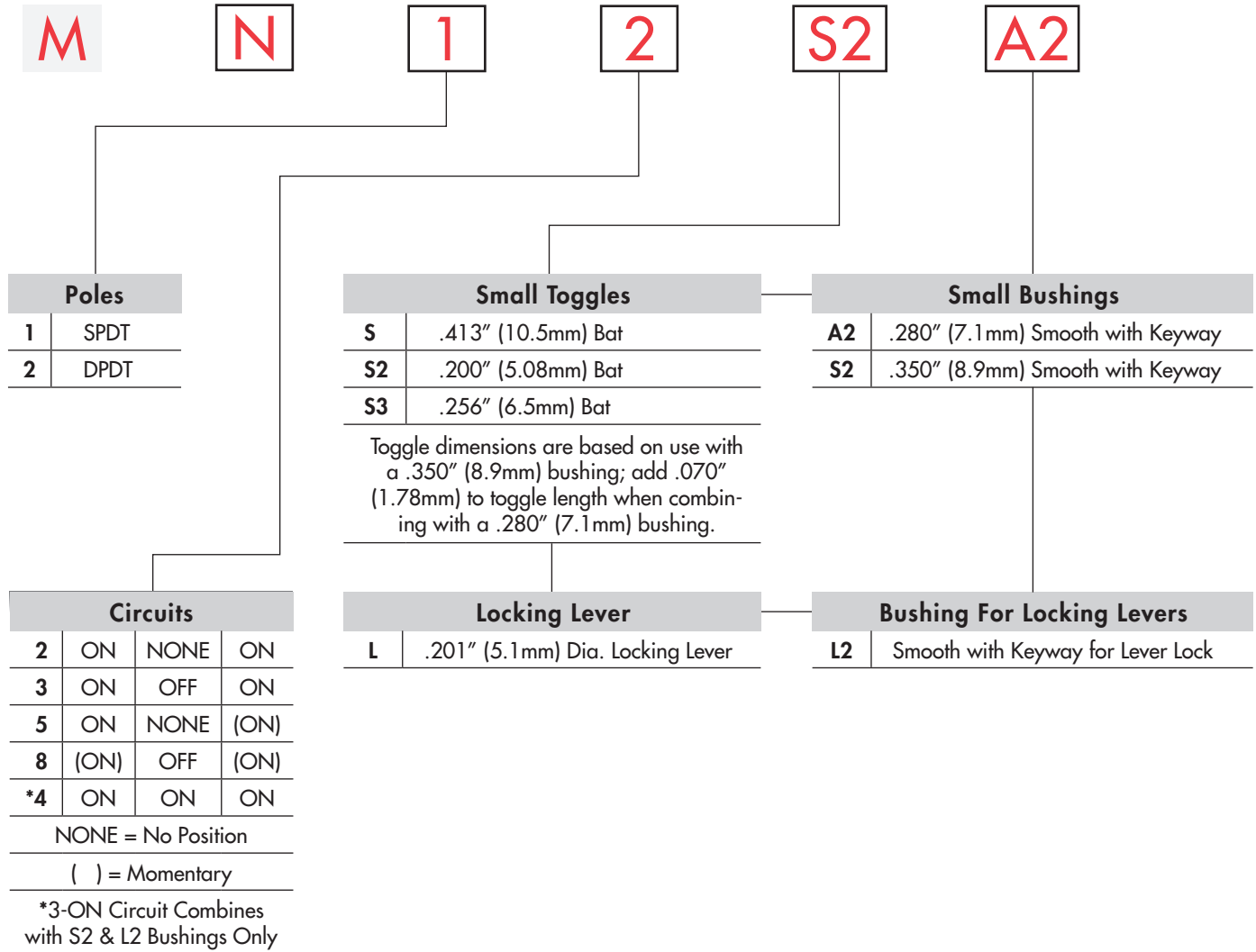

## ORDERING EXAMPLE

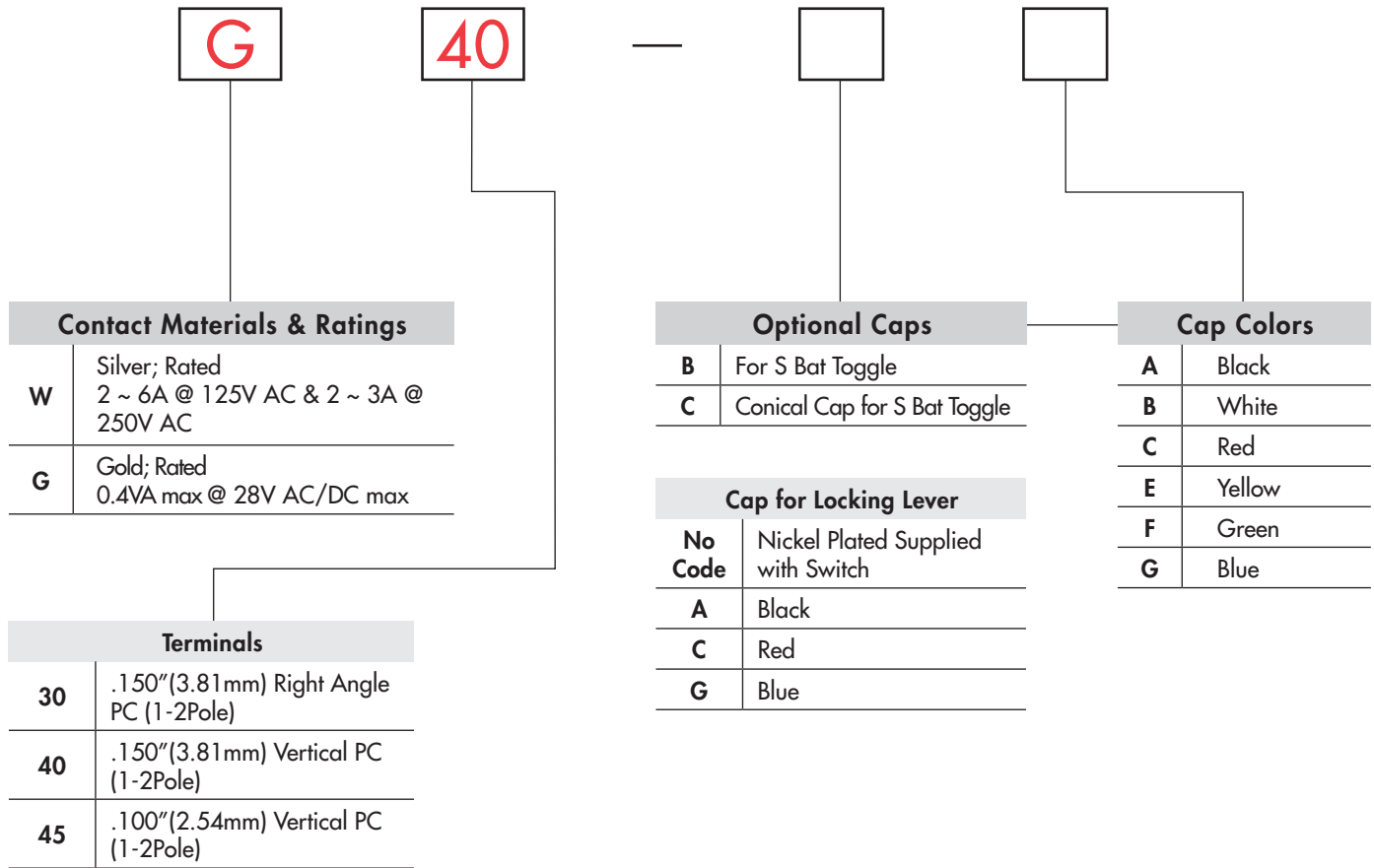

### DESCRIPTION FOR TYPICAL ORDERING EXAMPLE

### MN12S2A2G40

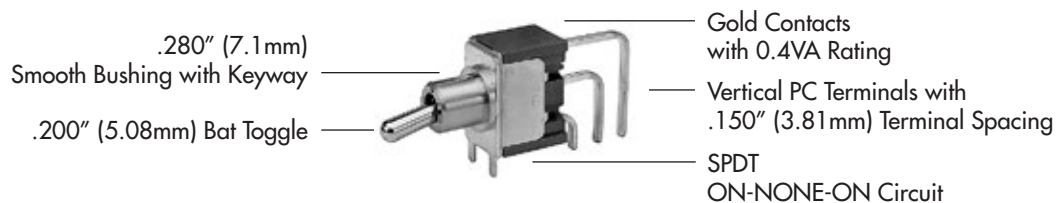

## POLES & CIRCUITS

Pole	Model	Toggle Position			Connected Terminals			Throw & Schematics
		Down	Center	Up	Down	Center	Up	
		NONE = No Position ( ) = Momentary						
								Note: Terminal numbers are not actually on the switch. *Reverse circuits available for vertical mount SP & DP upon request.
SP	MN12 *MN13 MN15 *MN18	ON	NONE	ON	2-3	OPEN	2-1	
DP	MN22 *MN23 MN25 *MN28	ON	NONE	ON	2-3 5-6	OPEN	2-1 5-4	

### For 3 Throw (3-On)

Pole	Model	Connected Terminals & Schematics			External Connection
		Down	Center	Up	
SP	MN24	ON 2-3 5-6	ON 2-3 5-4	ON 2-1 5-4	The SP3T model utilizes a double pole base.  External connection must be made during field installation.

## SMALL TOGGLES

### Important:

Toggle length changes based on bushing selected. All illustrations are shown with .350" (8.9mm) long bushing. When using a .280" (7.1mm) long bushing, toggle length increases .070" (1.78mm).

**S** .413" (10.5mm) Bat

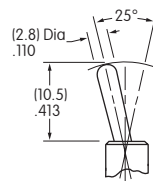

**S2** .200" (5.08mm) Bat

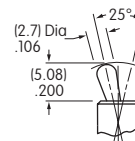

**S3** .256" (6.5mm) Bat

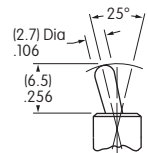

Standard Material & Finish: Brass with Bright Chrome  
Contact factory for optional finishes.

## SMALL BUSHINGS

**A2** .280" (7.1mm) Smooth with Keyway

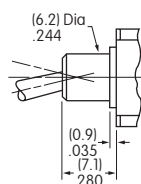
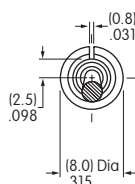

**S2** .350" (8.9mm) Smooth with Keyway

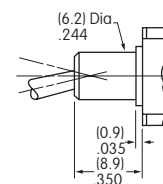
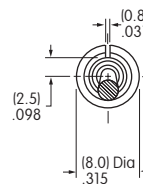

When using this bushing, toggle length is increased by .070" (1.78mm).

For A2 or S2 Bushing with Keyway

### Panel Cutout

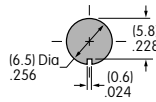

## LOCKING LEVER & BUSHING

**LL2** Smooth with Keyway

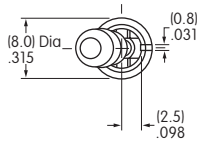

### Locking Mechanism

on-none-on



2 positions lock

on-none-(on)



1 position locks

on-off-on

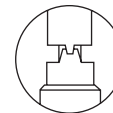

3 positions lock

(on)-off-(on)

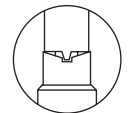

1 position locks

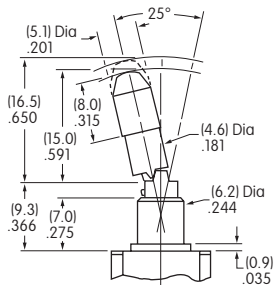

**No Code**

Cap for Locking Lever

Supplied with Cap AT427 Material & Finish:

Brass with Nickel Plating

Lever Material & Finish:

Brass with Chrome Plating

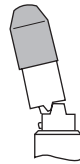

Color Codes for Optional Anodized Aluminum Caps

**A**

Black

**C**

Red

**G**

Blue

## CONTACT MATERIALS & RATINGS

**W** Silver Power Levels

**MN12, MN22:** 6A @ 125V AC, 3A @ 250V AC, 4A @ 30V DC  
**MN13, MN15, MN18, MN23, MN25:** 6A @ 125V AC, 3A @ 250V AC, 3A @ 30V DC  
**MN28:** 4A @ 125V AC, 3A @ 250V AC, 3A @ 30V DC  
**MN24:** 2A @ 125V AC, 2A @ 250V AC, 2A @ 30V DC

**G** Gold

Logic Level

0.4VA maximum @ 28V AC/DC maximum

Note: See Supplement section to find complete explanation of operating range.

Gold over Silver

Power Level or Logic Level

See above for each ratings

Note: This dual rated toggle is available as a custom option and suitable when two or more identical switches are used in logic and in power circuits within the same application. See Supplement section to find complete explanation of dual rating and operating range.



## TERMINALS

**30** .150" (3.81mm)  
Right Angle PC (1-2 Pole)

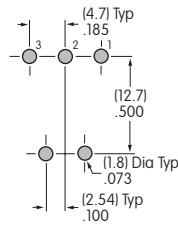
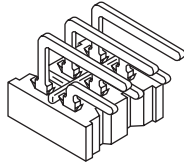

Single Pole

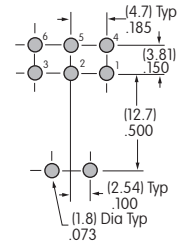

Double Pole

**40** .150" (3.81mm)  
Vertical PC (1-2 Pole)

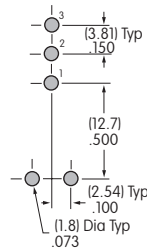
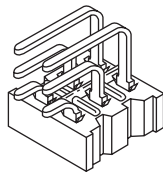

Single Pole

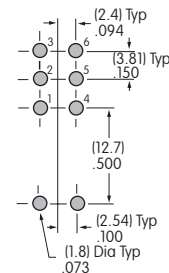

Double Pole

**45** .100" (2.54mm)  
Vertical PC (1-2 Pole)

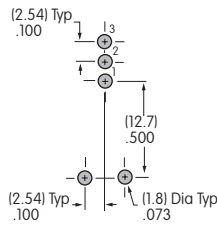
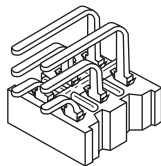

Single Pole

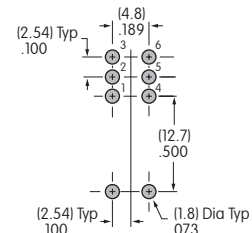

Double Pole

Terminal dimensions are shown on the Typical Switch Dimensions pages which follow.

## OPTIONAL CAPS & CAP COLORS

**B** \* AT415  
for S Bat Toggle

Material:  
Polyethylene

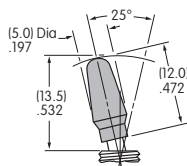

**C** \* AT444  
Conical Cap for S Bat Toggle

Material:  
Polyethylene

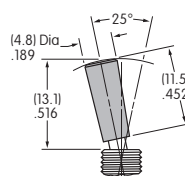

Colors Available

<b>A</b> Black	<b>E</b> Yellow
<b>B</b> White	<b>F</b> Green
<b>C</b> Red	<b>G</b> Blue

\* AT415 and AT444 for use with S toggles only, not S2 or S3 toggles.

## TYPICAL SWITCH DIMENSIONS

### Single Pole

### .150" (3.81mm) Right Angle PC

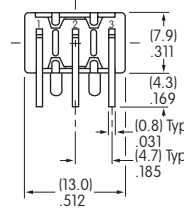
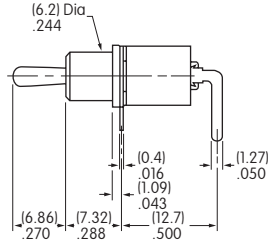
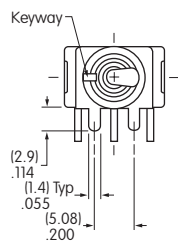

**MN12S2A2W30**

### Double Pole

### .150" (3.81mm) Right Angle PC

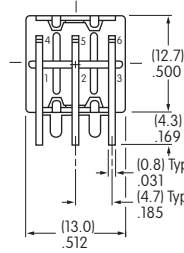
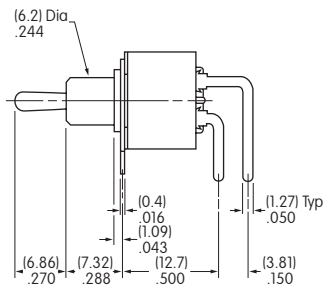
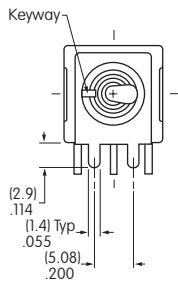

**MN22S2A2G30**

### Single Pole

### .150" (3.81mm) Vertical PC

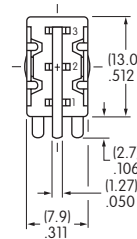
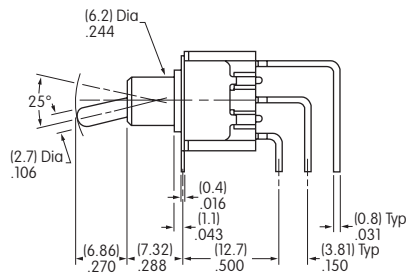
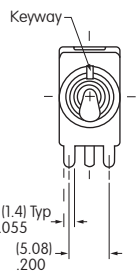

**MN12S2A2G40**

## TYPICAL SWITCH DIMENSIONS

### .150" (3.81mm) Vertical PC

### Double Pole

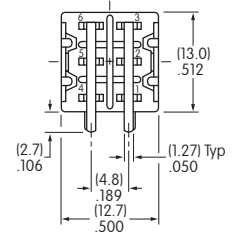
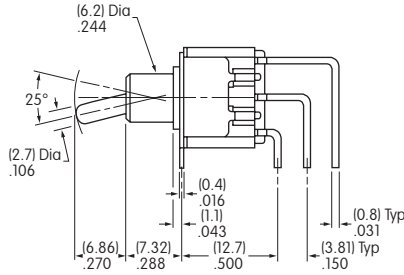
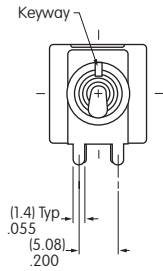

**MN22S2A2G40**

### .100" (2.54mm) Vertical PC

### Single Pole

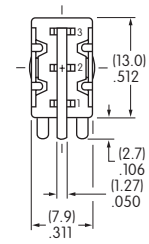
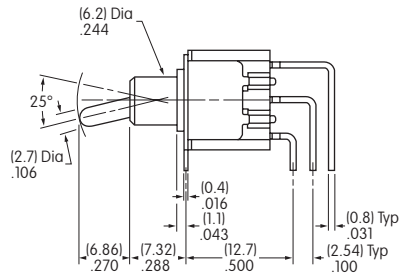
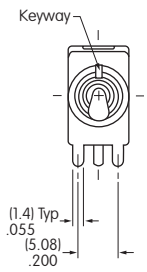

**MN12S2A2G45**

### .100" (2.54mm) Vertical PC

### Double Pole

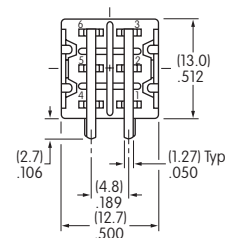
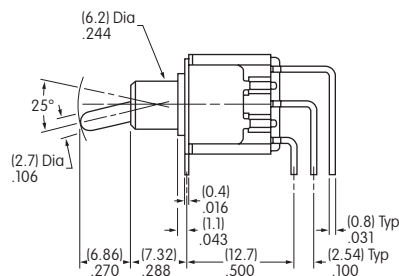
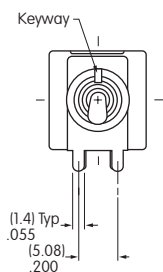

**MN22S2A2G45**

